



# powRgrip® System

The ambitious toolholding system

Product catalog

**REGO-FIX** 

**Providing solutions for cutting-edge toolholding**

Product offering	04	Customer testimonial: powRgrip® in use	08
Discover powRgrip®	06	Special solutions: XL toolholders	10
Automatic clamping unit PGU	07	Special solutions: PG secuRgrip®	12

**1.0 PG toolholders****Minimize runout – boost productivity 17**

1.1 Standard spindle toolholders		1.2 PG secuRgrip® toolholders	
1.1.1 CAT	18	CAT, SK, BT, BT+, HSK, C	54
1.1.2 SK	24		
1.1.3 BT	30	1.3 PG tapping holders	
1.1.4 HSK	38	HSK-A SSY, CYL SSY, CYL GSF	58
1.1.5 REGO-FIX CAPTO <small>licensed by Sandvik Coromant</small>	46		
1.1.6 Cylindrical (CYL)	50		
1.1.7 ISO 20 interface	52		







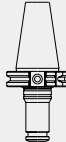

**2.0 PG collets****The most powerful collets yet 63**

2.1 PG collets		2.2 Tapping collets PG-TAP	78
2.1.1 Microbore collets PG-MB	66		
2.1.2 PG standard collets	67		
2.1.3 Coolant flush collets PG-CF	70		
2.1.4 Long shank collets PG-L	73		
2.1.5 Short shank collets PG-S	74		
2.1.6 Turning collets PG-T	76		
2.1.7 secuRgrip® collets PG-SG	77		

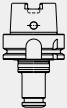

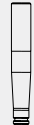

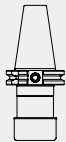
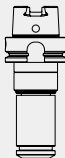



3.0 Accessories	80
-----------------	----

4.0 Technical information	88
---------------------------	----

# Experience the powerful powRgrip® range

Standard					Cylindrical collets	Pullout protection secuRgrip®	Colletholders for tapping		
CAT/PG	SK/PG	BT/PG	HSK/PG	REGO-FIX CAPTO/PG licensed by Sandvik Coromant	CYL/PG	ISO 20/PG	PG-SG	HSK-A SSY	CYL SSY CYL GSF
									
page 18	page 24	page 30	page 38	page 46	page 50	page 52	page 54	page 61	page 61

1.0 PG toolholders

Micro machining	Standard	Cooling	Long shanks	Short shanks	Turning collets	Pullout protection secuRgrip®	Collets for tapping
PG-MB	PG	PG-CF	PG-L	PG-S	PG-T	PG-SG	PG-TAP
							
page 66	page 67	page 70	page 73	page 74	page 76	page 77	page 78

2.0 PG collets

Suitable for carbide or HSS milling cutter in all shank forms (Weldon, Whistle-Notch, etc.)

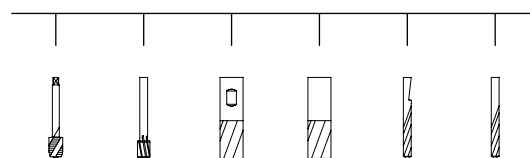

For the automatic clamping unit PGU 9500 and other accessories please refer to page 80.

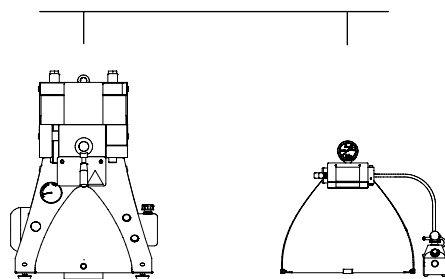



At a glance

## Providing solutions for cutting-edge toolholding

Our holistic toolholding systems excel with extraordinary reliability, high precision and outstanding quality.

**Pioneering spirit** Fritz Weber, a Swiss master craftsman, tapped into the promising optimism in the 1950s and founded a small business called Fritz Weber Feinmechanik und Werkzeugbau. With his innovative spirit and stern determination, Fritz Weber gradually expanded his range of products. The company, now called REGO-FIX AG, achieved international recognition in 1972 with the invention of the ER clamping system, changing the toolholding industry forever. The ER System, made in Switzerland, is an industrial standard clamping element. It set the industry standard and even became DIN Standard (DIN 6499) in 1993. Today, the ER collet made by REGO-FIX is still the most used clamping collet worldwide.

**Shaping the future** REGO-FIX is an international family-owned company that is run by the sons of Fritz Weber. With its over 220 employees, REGO-FIX manufactures and markets high-precision toolholding systems worldwide. Headquartered

in Tenniken, Switzerland, the company has established itself as one of the leading manufacturers of toolholding systems and enjoys an excellent industry-wide reputation. Through its close network of distributors and subsidiaries in the US and China, REGO-FIX is strategically well positioned and possesses a worldwide presence in key markets. With groundbreaking product inventions, REGO-FIX developed from a small company to a global solution provider for cutting-edge toolholding systems. At the core of every product lies an aim for machining excellence and a passion for precision.

**Cradle of precision** REGO-FIX manufactures its products in Switzerland to fit highest quality standards. The products are used in the fields of automotive, aerospace, medical engineering, watchmaking, telecommunications and also in the die and mold industry.



powRgrip® System

## Meet high machining demands

The powRgrip System provides excellent runout, high-vibration dampening as well as easy and secure handling for demanding high-speed milling and drilling. The clamping unit PGU 9500 has been awarded a Red Dot award for industrial design, highlighting the good usability and outstanding design of the machine.

### Key advantages

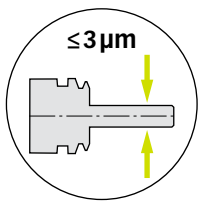

Total system runout  
TIR  $\leq 3 \mu\text{m}$  at  $3 \times D$ .

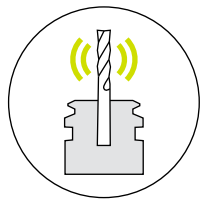

Excellent vibration dampening.

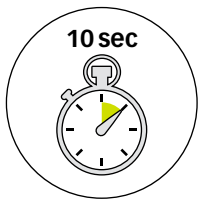

Tool ready for use in less  
than 10 seconds.

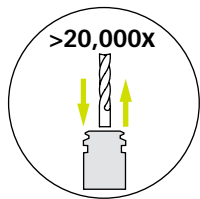

Maximum clamping force and  
low runout, even after 20,000 tool  
changes.

**Power and precision combined** An outstanding tool runout is one of the most positive influences on enhancing your tool life.

### Increased cutter tool life with the powRgrip® System

Influence of tool runout on tool life / Source: In-house testing

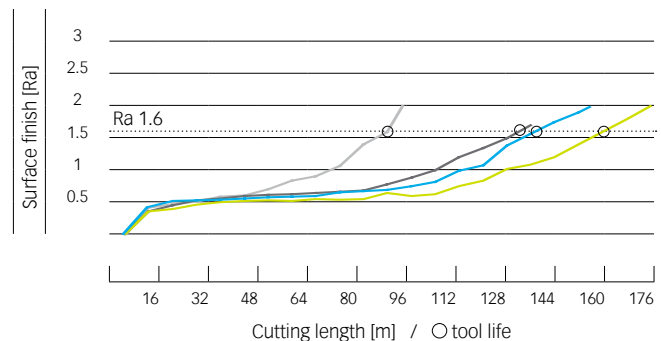

- powRgrip®
- REGO-FIX ER system with Hi-Q® clamping nut
- Shrink-fit
- Hydro-chuck

# Three systems – one brand

Our brand unites three different toolholding systems. Each system has different strengths to fit your machining needs, but at the heart of each system lies our aim for toolholding excellence.

## powRgrip® System

For high-end machining with a total system **TIR ≤ 0.0001" (3 µm) at 3xD**

### PG toolholders

Taper accuracy AT3

Surface finish  
max. Ra 0.25

High transferable torque  
up to 1,100 Nm

### PG collets

Clamping range  
from 0.0079" up to 1"

Highly durable coating  
ensures longevity

Clamps all shanks  
with tolerance h6

Vibration dampening  
for high RPM

### A holistic system approach

All parts are designed for exclusive fit to ensure toolholding excellence.

## ER System

Our ideal system for standard machining

### ER toolholders

Runout TIR ≤ 0.0001" (3 µm)

Taper accuracy AT3

Surface finish max. Ra 0.25

Factory balanced

### ER collets

Wide clamping range: from ER 8 up to ER 50 and  
for diameters from 0.0079" up to 1.375"

Clamping capacity 0.0197" to 0.0787"

Runout TIR ≤ 0.0004" (10 µm) at 3xD for ER standard

Runout TIR ≤ 0.0002" (5 µm) at 3xD for ER-UP

### ER clamping nuts

Collet-locking system

Balanced by design

Special coating improves transferable torque  
and protects against corrosion

## micRun® System

Total system TIR  $\leq 0.0001"$  (3  $\mu\text{m}$ ) at 3xD

### MR toolholders

Taper accuracy AT3

Polished surface for improved performance

Balanced for high RPM

Vibration dampening

### MR collets

Clamping range from 0.0394" to 0.7874"

Nominal diameter shanks h11

### MR clamping nuts

Collet-locking system

Balanced by design

Grooveless design for higher RPM

Freewheel wrench head

### A holistic system approach

All parts are designed for exclusive fit to ensure toolholding excellence.

# Concentricity and optimum vibration damping saves time and money

**Ambitious toolholding** Thanks to the unique clamping method of the PGU, clamped tools can be used in production quickly and safely. The advanced technology not only increases the work safety for the user, but also reflects our ecological thinking, which manifests itself – among other things – through low energy consumption during the clamping process. The clamping unit clamps the powRgrip collet into the toolholder with a force of up to nine tons. The pressure fit provided between the collet and toolholder creates a radial force, which is concentrated on the tool shank via the slotted collet and holds the tool safely and with a high degree of concentricity.

## The powRgrip® System consists of

- // High-precision powRgrip collet
- // powRgrip toolholder
- // powRgrip clamping unit (automatic or manual)

## How the powRgrip® System works

- // Insert the powRgrip collet into the powRgrip toolholder
- // Insert the cutting tool into the powRgrip collet
- // Clamp collet and cutting tool into the powRgrip toolholder with a powRgrip clamping unit PGU (automatic) or PGC (manual)



Cutting tool



powRgrip® collet



powRgrip® toolholder



Automatic clamping unit PGU



Manual clamping unit PGC



# Toolholding made fast, safe and easy

The clamping unit PGU 9500 has been awarded the Red Dot design award for industrial design, highlighting the good usability and outstanding design of the machine.



reddot award 2015  
honourable mention industrial design

## Key advantages

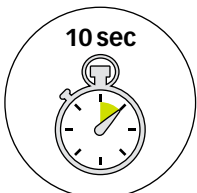

Clamp the tool safely and securely by pushing just one button. The clamping will take less than 10 seconds, without the use of heat.

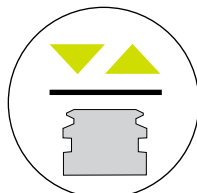

Clamp tools with maximum clamping force and best runout in the powRgrip collet and toolholder.

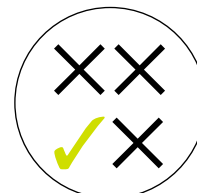

Smart System – no setting of parameters required. Clamping pressure is controlled by the insertion of the respective clamping insert (APG). There are five clamping inserts (APG) available for the clamping of different collet sizes.

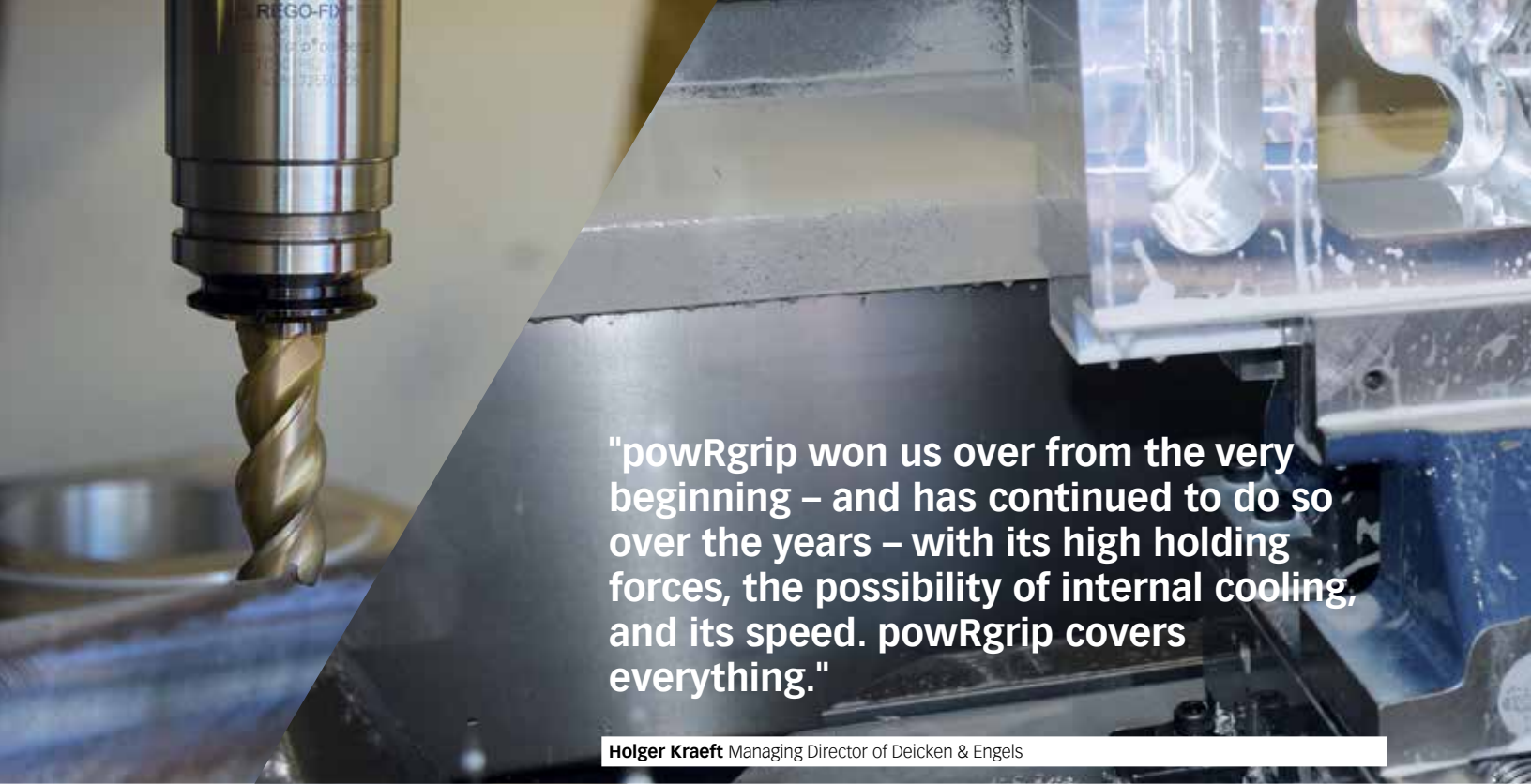

"powRgrip won us over from the very beginning – and has continued to do so over the years – with its high holding forces, the possibility of internal cooling, and its speed. powRgrip covers everything."

**Holger Kraeft** Managing Director of Deicken & Engels

Customer testimonial: powRgrip® in use

## Going all in with powRgrip

Contract manufacturer Deicken & Engels Maschinenfabrik GmbH & Co. KG has based its entire production on a single toolholding system: powRgrip. The company in northern Germany has experienced firsthand the flexibility of powRgrip and its runout accuracy and speed.

**Improving efficiency and reducing costs** "During the course of a machine and tooling technology changeover to solid carbide high-speed tools in 2009, we made our initial investment in the powRgrip toolholding system, which established the basis for our highly innovative production," explained Holger Kraeft, Managing Director of Deicken & Engels.

**Remarkable flexibility** "Initially, the focus was on setting up cutting data and the acquisition of new machines and tools. The next step is now the optimization process—improving efficiency, reducing costs, and saving time." This is where powRgrip plays a central role in Stuhr, because the toolholding system from REGO-FIX is the only system used in the entire production. Just one system for grinding, finishing, roughening, and thread-cutting – proof of the high flexibility of powRgrip. In the meantime, two powRgrip units are used for all applications in the production. This is all the more noteworthy, because Deicken & Engels serves a very broad

diversity of customers and industries, thus handling a wide variety of materials and work processes.

**Workmaterial flexibility** Materials such as aluminium alloys, common structural steels, stainless steels, high-strength alloys, plastics, forged stainless steels, and special steels with high tensile strengths of up to 1,200 N/mm<sup>2</sup> are difficult to machine, but they can all be mastered with powRgrip. After years of use, no one at Deicken & Engels can recall a time in which they could not count on the strengths of powRgrip – with its runout accuracy and holding force.

The set up (tool change times) and the question of how to save time were also an important emphasis at the northern German company. Deicken & Engels operates with the strategy of always keeping 60 basic tools in the machine. Before powRgrip®, all the tools in the machine had to be changed out. Now the contract manufacturer works with



a base stock of tools which remain in the machine. With a 100-piece tool magazine, basic equipment with 60 tools remain in the machine and can be used for approximately 80% of all machining. With this strategy, a greater initial investment had to be made for the basic equipment of the machines. In the long run this way is without a doubt the more sustainable investment.

Deicken & Engels has achieved improvements in production with the extra-long powRgrip toolholders, purchased from REGO-FIX as standard equipment. Even with the pivot-head machines that the company uses, the machining of workpieces is sometimes a challenge. The system is already a great help – but the bar is being constantly raised. If an extension of 400 mm is sufficient today, the customer will assume tomorrow that a standard of 500 mm will be available. In combination with the Coromant Capto interface, the contract manufacturer achieves very good results with extra-long toolholders and optimal results with the standard lengths supplied by REGO-FIX.

**True fans** powRgrip has absolutely proven its value at Deicken & Engels. The advantages of the system – perfection and precision – were quickly recognized. Deicken & Engels consider themselves to be big powRgrip fans and are convinced that their production is now well-armed for a successful future.

At a glance

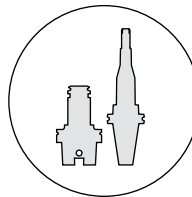

XL length toolholders are standard in the REGO-FIX product range and are immediately available. Their long and slim design allows for precise machining even with limited space.

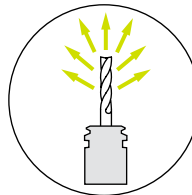

Ultimate work material flexibility with powRgrip. Even difficult-to-machine materials with high tensile strengths can be machined successfully.

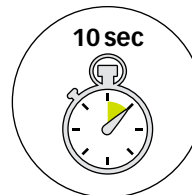

Clamp the tool safely and securely by pushing just one button. The clamping will take less than 10 seconds, without the use of heat.

# XL vibration dampening

Optimize your surface finish and extend tool life by minimizing occurring vibrations during machining.

**Minimize tool vibrations** The MICRO-FRICTION DAMPENING™ (MFD) technology (pat. pend.) by REGO-FIX allows our XL toolholders to dissipate vibrations faster than standard long-reach toolholders. Dampening the vibrations faster means that your cutting tool, part and spindle will see less vibrations resulting in better surface finishes, longer tool life and less spindle wear. All REGO-FIX XL toolholders are balanced to G 2.5 @ 5,000 rpm.

## Key advantages

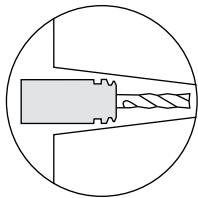

Minimal outside dimensions: long and slim design.

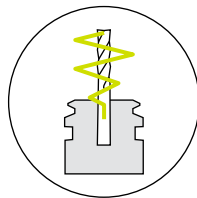

Exclusive vibration-dampening design.

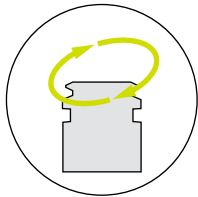

Balanced by design.

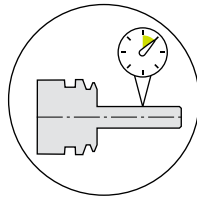

Total system runout TIR  $\le 10 \mu\text{m}$  at 3x D.





# Form-fit for 100% pullout protection

With our innovative secuRgrip® solution, we offer a total tool pullout protection for the PG System.

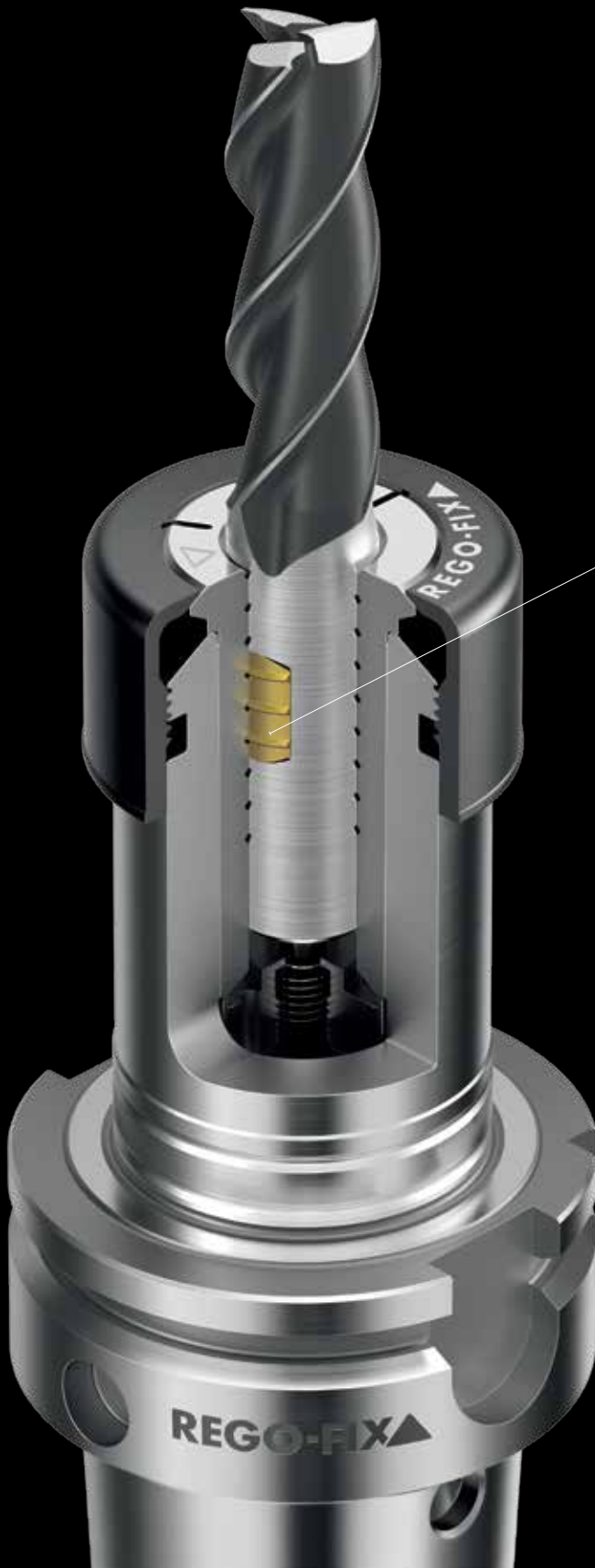

Threaded insert for end mill flat

## Key advantages

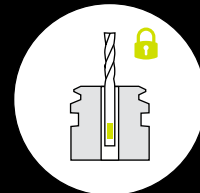

PG secuRgrip® is available for all standard tools with Weldon flat (10–25.4 mm), without additional modifications.

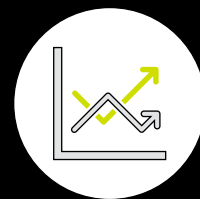

Increase productivity through process reliability.

# Safe machining even for difficult-to-handle workpieces

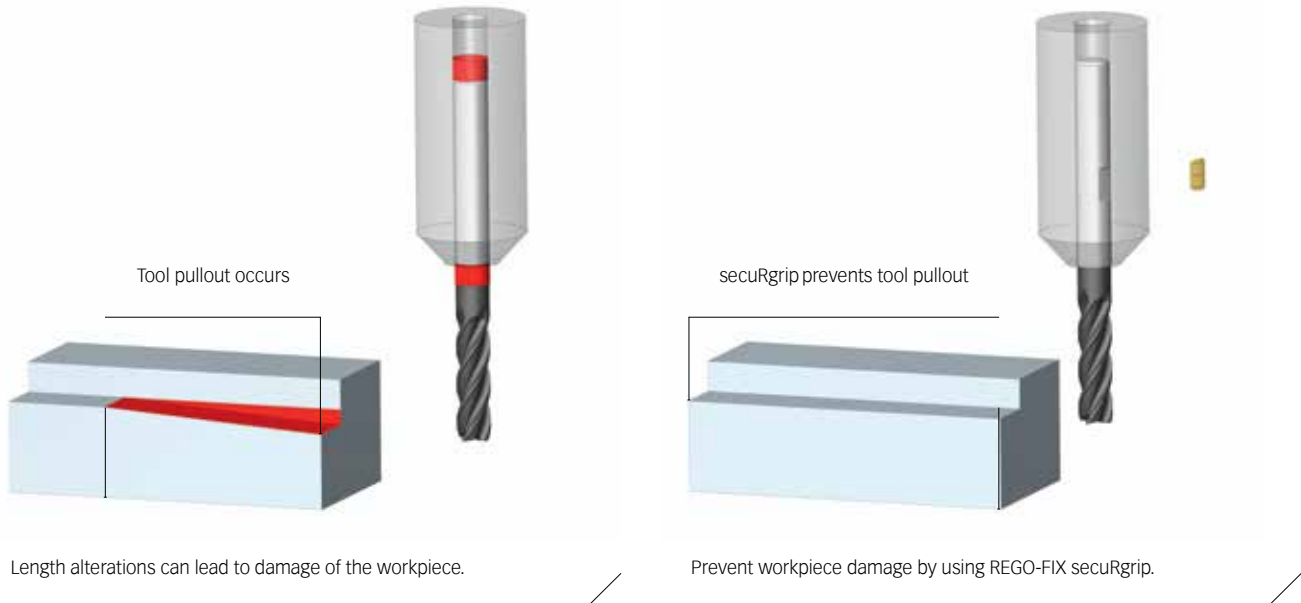

**Full protection where you need it** The secuRgrip threaded insert is designed to fit in any tool with a Weldon flat. This way you can use the tool of your choice. In combination with our PG secuRgrip collet, we offer the ultimate tool pullout protection at a competitive price. Avoiding length alterations caused by tool pullout results in improved process reliability and ultimately improves your overall machining productivity. Our secuRgrip solution is available for PG 15, PG 25 and PG 32 – just the right sizes when it comes to rough machining.

#### Key Advantages

- // No additional costs for replacing damaged tools, thanks to PG secuRgrip
- // No modification of the tool shank is required
- // Extra protection for worry-free machining, especially with expensive workpieces

## All-new Heavy Duty secuRgrip Toolholders

**HD-SG PG Holders** New Heavy Duty secuRgrip toolholders are up to two times more rigid than standard holders. And, they include secuRgrip design for 100% protection against tool pullout.

#### Features

- // Includes secuRgrip design to prevent pullout
- // Most designs retain the use of balance rings
- // Fits existing powRgrip clamping units

#### Key Advantages

- // Up to 2 times more rigid than standard holders
- // Increases feed rates to maximize tooling efficiency
- // Better surface finish with less deflection















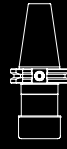

**Customers from all around the world  
rely on Swiss-made REGO-FIX products.  
From Tenniken, we deliver to customers  
in fast-paced industries with  
the highest demands for precision.**

We offer competitive solutions

Standard				Cylindrical collets		Pullout protection secuRgrip®		Collet holders for tapping	
CAT/ PG	SK/ PG	BT/ PG	HSK/ PG	REGO-FIX CAPTO/PG licensed by Sandvik Coromant	CYL/ PG	ISO 20/ PG	PG-SG	HSK-A SSY	CYL SSY CYL GSF
									
page 18	page 24	page 30	page 38	page 46	page 50	page 52	page 54	page 61	page 61



# Minimize runout – boost productivity

**Experience outstanding quality** We at REGO-FIX know how to minimize your runout and boost your productivity. This is why we designed our powRgrip® toolholders to fulfill diverse criteria all crucial for achieving machining excellence.

The outstanding design paired with our experienced engineering make the powRgrip products one of our most powerful toolholding options. Our PG clamping collets tout a solid collet TIR of down to 1 µm, leading to a total system runout of max. TIR of 3 µm. Further increases in machining productivity are possible by incorporating our matching items.

The PG toolholder and collet together make the PG System a high-quality and high-precision option for challenging machining applications. What you see is what you get: all our products bear the REGO-FIX triangle – our seal for outstanding Swiss quality.

**True power** A competitor comparison indicates that the transferable torque with powRgrip is more than twice as high as the same tool shank diameter clamped with a shrink-fit method. This results in powRgrip being the ultimate toolholding system for HPC and HSC cutting.

## Transferable torque of the powRgrip® System

Measured transferable torque per shank diameter / Source: In-house testing

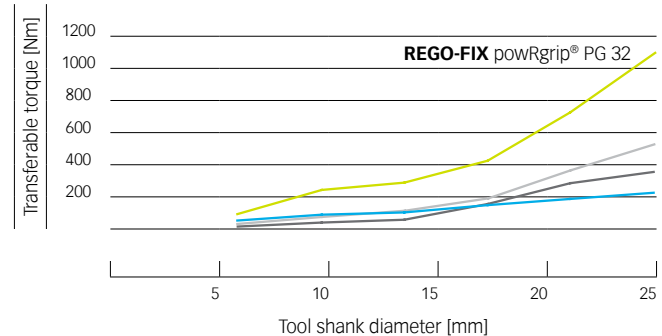

- powRgrip® PG 32
- Shrink-fit
- Hydro chuck
- REGO-FIX ER 40



### Swiss quality standard

Our products marked Swiss made are manufactured at our headquarters in Tenniken, Switzerland.

# CAT steep taper toolholders

Universally suitable for different machining applications.

DIN 69871 / DIN ISO 7388-1

## Features and benefits

### Total system runout TIR $\leq 0.0001''$ (3 $\mu\text{m}$ )

Our holistic system consists of a powRgrip® toolholder and collet. All components together ensure best runout and accuracy.

### Toolholder runout TIR $\leq 1 \mu\text{m}$

Measured from collet cavity to outer taper.

### Taper accuracy AT3

Better spindle-to-holder fit and accuracy.

### Surface finish max. Ra 0.25

Achieve high clamping force and high transferable torque.

### Balancing

100 % balanced to G 2.5 @ 22,000 rpm.

### Balancing in XL toolholders

100 % balanced to G 2.5 @ 5,000 rpm.

### Hi-Q® balancing system

Ready to accept Hi-Q® balancing rings which allow for the offset of the imbalance introduced by the cutting tool up to 80,000 rpm depending on the balancing rings used. All toolholders with the additional type information "H" in the part number are designed for balancing rings.

### Vibration dampening

Our holders offer good vibration dampening to sustain a high surface finish and can help prevent chatter.

### ID chip hole

In accordance with DIN 69873 for 10 mm diameter.





## CAT/PG and CAT/PG XL toolholders

### Applications

These toolholders are designed for CNC-machining centers with an automatic tool changer. They are universally suitable for different machining applications. Their vibration dampening reduces spindle wear and extends tool life.

### Balancing

REGO-FIX CAT/PG toolholders are balanced to G 2.5 @ 22,000 rpm. Type H toolholders are ready to accept Hi-Q® balancing rings which allow precision balancing of the system including cutting tool up to 80,000 rpm depending on the balancing rings used.

### CAT/PG XL available

Due to their good vibration dampening characteristics, CAT/PG XL holders are ideally suited in all machining processes where the standard length toolholders cannot be used. All REGO-FIX XL toolholders are balanced to G 2.5 @ 5,000 rpm.

*For more details on our XL toolholders, please refer to page 10.*

### Cooling options

PG standard collets for tools with an internal coolant supply (metallic sealed).  
Coolant flush collets PG-CF for peripheral cooling.

### Matched tooling system for best fit

For highest precision and best results the entire machining system counts. Therefore REGO-FIX components are carefully matched for optimum fit and accuracy. This guarantees the best runout and balance.

*For the influence of runout on tool life, please refer to page 3.*

Type	Part no.	Dimensions						Accessory
		D [mm]	D1 [mm]	D2 [mm]	L [inch]	L1 [inch]	L2 [mm]	FWR ...*
<b>CAT 40</b>								
CAT 40 / PG 6 x 3" H	4340.70631	10	-	-	3"	-	-	285
CAT 40 / PG 10 x 3.5" H	4340.71001	16	-	-	3.5"	-	-	285
CAT 40 / PG 10 x 6" H	4340.71071	16	-	-	6"	-	-	285
CAT 40 / PG 10 x 8" XL	8843.71031	16	42	28	8"	4"	31	-
CAT 40 / PG 10 x 10" XL	8843.71081	16	42	28	10"	4"	31	-
CAT 40 / PG 10 x 12" XL	8843.71131	16	42	28	12"	8"	31	-
CAT 40 / PG 10 x 14" XL	8843.71181	16	42	28	14"	8"	31	-
CAT 40 / PG 15 x 3.15" H	4340.71541	24	-	-	3.15"	-	-	285
CAT 40 / PG 15 x 4" H	4340.71551	24	-	-	4"	-	-	285
CAT 40 / PG 15 x 6" H	4340.71571	24	-	-	6"	-	-	325/285
CAT 40 / PG 15 x 8" XL	8843.73031	24	42	28	8"	4"	55	-
CAT 40 / PG 15 x 10" XL	8843.73081	24	42	28	10"	4"	55	-
CAT 40 / PG 15 x 12" XL	8843.73131	24	42	28	12"	8"	55	-
CAT 40 / PG 15 x 14" XL	8843.73181	24	42	28	14"	8"	55	-
CAT 40 / PG 25 x 2.8"	2340.72531	40	-	-	2.8"	-	-	-
CAT 40 / PG 25 x 3.15" H	4340.72541	40	-	-	3.15"	-	-	405
CAT 40 / PG 25 x 4" H	4340.72551	40	-	-	4"	-	-	405
CAT 40 / PG 25 x 6" H	4340.72571	40	-	-	6"	-	-	405/405
•CAT 40 / PG 25 x 8"	4340.72591	40	52	-	8"	-	-	-
CAT 40 / PG 25 x 10" XL	8843.76081	40	52	-	10"	4"	-	-
CAT 40 / PG 25 x 14" XL	8843.76181	40	52	-	14"	8"	-	-
CAT 40 / PG 32 x 3.5"	2340.73201	50	-	-	3.5"	-	-	-
CAT 40 / PG 32 x 4.3" H	4340.73251	50	-	-	4.3"	-	-	505
CAT 40 / PG 32 x 6" H	4340.73271	50	-	-	6"	-	-	505/505
<b>CAT-B 40</b>								
CAT 40 / PG 10 x 3.5" H	4340.71004	16	-	-	3.5"	-	-	285
CAT 40 / PG 10 x 6" H	4340.71074	16	-	-	6"	-	-	285
CAT 40 / PG 15 x 3.15" H	4340.71544	24	-	-	3.15"	-	-	285
CAT 40 / PG 15 x 4" H	4340.71554	24	-	-	4"	-	-	285
CAT 40 / PG 15 x 6" H	4340.71574	24	-	-	6"	-	-	325/285
CAT 40 / PG 25 x 3.15" H	4340.72544	40	-	-	3.15"	-	-	405
CAT 40 / PG 25 x 4" H	4340.72554	40	-	-	4"	-	-	405
CAT 40 / PG 25 x 6" H	4340.72574	40	-	-	6"	-	-	405/405
CAT 40 / PG 32 x 4.3" H	4340.73254	50	-	-	4.3"	-	-	505
CAT 40 / PG 32 x 6" H	4340.73274	50	-	-	6"	-	-	505/505

\* Balancing rings H: Ready to accept balancing rings

•Holder is mono-block design and does not feature vibration dampening technology.  
Maximum 5,000 rpm

Accessories are not included in delivery.

Other XL sizes available on request.

Type	Part no.	Dimensions [mm]						Accessory
		D [mm]	D1 [mm]	D2 [mm]	L [inch]	L1 [inch]	L2 [mm]	FWR ...*
<b>CAT 50</b>								
CAT 50 / PG 10 x 4" H	4350.71051	16	-	-	4"	-	-	405
CAT 50 / PG 10 x 8" XL	8853.71031	16	42	28	8"	4"	31	-
CAT 50 / PG 10 x 10" XL	8853.71081	16	42	28	10"	4"	31	-
CAT 50 / PG 10 x 12" XL	8853.71131	16	42	28	12"	8"	31	-
CAT 50 / PG 10 x 14" XL	8853.71181	16	42	28	14"	8"	31	-
CAT 50 / PG 15 x 4" H	4350.71551	24	-	-	4"	-	-	405
CAT 50 / PG 15 x 8" XL	8853.73031	24	42	28	8"	4"	55	-
CAT 50 / PG 15 x 10" XL	8853.73081	24	42	28	10"	4"	55	-
CAT 50 / PG 15 x 12" XL	8853.73131	24	42	28	12"	8"	55	-
CAT 50 / PG 15 x 14" XL	8853.73181	24	42	28	14"	8"	55	-
CAT 50 / PG 25 x 4" H	4350.72551	40	-	-	4"	-	-	505
CAT 50 / PG 25 x 6" H	4350.72571	40	-	-	6"	-	-	505/405
CAT 50 / PG 25 x 8.3" XL	8853.76041	40	52	-	8.3"	4"	-	-
CAT 50 / PG 25 x 10" XL	8853.76081	40	52	-	10"	4"	-	-
CAT 50 / PG 25 x 14" XL	8853.76181	40	52	-	14"	8"	-	-
CAT 50 / PG 32 x 3.1" H	2350.73231	50	-	-	3.1"	-	-	-
CAT 50 / PG 32 x 4.3" H	4350.73251	50	-	-	4.3"	-	-	505
CAT 50 / PG 32 x 6" H	4350.73271	50	-	-	6"	-	-	505/505
CAT 50 / PG 32 x 9.81" XL	8853.78071	50	58	-	9.81"	-	-	-
CAT 50 / PG 32 x 11.51" XL	8853.78121	50	58	-	11.51"	-	-	-
CAT 50 / PG 32 x 13.75" XL	8853.78171	50	58	-	13.75"	-	-	-
CAT 50 / PG 32 x 15.45" XL	8853.78221	50	58	-	15.45"	-	-	-

<b>CAT-B 50</b>								
CAT 50 / PG 25 x 4" H	4350.72554	40	-	-	4"	-	-	505
CAT 50 / PG 25 x 6" H	4350.72574	40	-	-	6"	-	-	505/405
CAT 50 / PG 32 x 4.3" H	4350.73254	50	-	-	4.3"	-	-	505
CAT 50 / PG 32 x 6" H	4350.73274	50	-	-	6"	-	-	505/505

\* Balancing rings H: Ready to accept balancing rings

Accessories are not included in delivery.

Other XL sizes available on request.

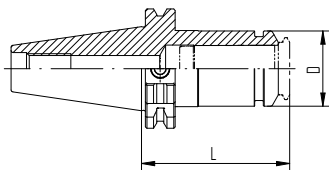

CAT / PG

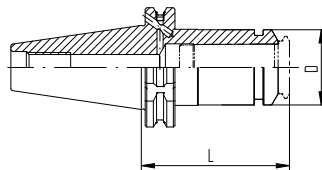

CAT-B / PG

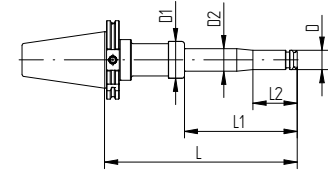

CAT / PG XL

# CAT+ REGO PLUS dual contact toolholders

**Certified** The BIG PLUS SYSTEM – licensed by BIG Daishowa – is manufactured at REGO-FIX in Switzerland under license according to BIG PLUS specifications.

## Key advantages

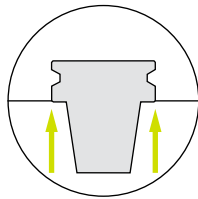

Higher toolholder stiffness due to taper (AT1) and face contact.

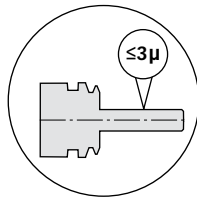

Total system runout TIR  $\leq 3\mu\text{m}$  at  $3 \times D$ .

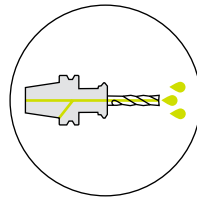

Form AD+B as standard configuration.

Type	Part no.	Dimensions [mm]						Accessory
		D [mm]	D1 [mm]	D2 [mm]	L [inch]	L1 [inch]	L2 [mm]	FWR ...*
<b>CAT+ 40</b>								
CAT+ 40 / PG 10 x 3.5" H	4340.71006	16	–	–	3.5"	–	–	285
CAT+ 40 / PG 10 x 6" H	4340.71076	16	–	–	6"	–	–	285
CAT+ 40 / PG 15 x 3.15" H	4340.71546	24	–	–	3.15"	–	–	285
CAT+ 40 / PG 15 x 6" H	4340.71576	24	–	–	6"	–	–	325/285
CAT+ 40 / PG 25 x 3.15" H	4340.72546	40	–	–	3.15"	–	–	405
CAT+ 40 / PG 25 x 6" H	4340.72576	40	–	–	6"	–	–	405/405
CAT+ 40 / PG 32 x 3.5" H	2340.73206	50	–	–	3.5"	–	–	–
CAT+ 40 / PG 32 x 6" H	4340.73276	50	–	–	6"	–	–	505/405
<b>CAT+ 50</b>								
CAT+ 50 / PG 10 x 4" H	4350.71056	16	–	–	4"	–	–	405
CAT+ 50 / PG 15 x 4" H	4350.71556	24	–	–	4"	–	–	405
CAT+ 50 / PG 15 x 6" H	4350.71576	24	–	–	6"	–	–	405
CAT+ 50 / PG 25 x 4" H	4350.72556	40	–	–	4"	–	–	505
CAT+ 50 / PG 25 x 6" H	4350.72576	40	–	–	6"	–	–	505/405
CAT+ 50 / PG 32 x 4.3" H	4350.73256	50	–	–	4.3"	–	–	505
CAT+ 50 / PG 32 x 6" H	4350.73276	50	–	–	6"	–	–	505/505

\* Balancing rings H: Ready to accept balancing rings

Accessories are not included in delivery.

Other XL sizes available on request.





# SK steep taper toolholders

Universally suitable for a variety of machining applications.

DIN 69871 / DIN ISO 7388-1

## Features and benefits

### Total system runout TIR $\leq 0.0001''$ (3 $\mu\text{m}$ )

Our holistic system consists of a powRgrip® toolholder and collet. All components together ensure best runout and accuracy.

### Toolholder runout TIR $\leq 1 \mu\text{m}$

Measured from collet cavity to outer taper.

### Taper accuracy AT3

Better spindle-to-holder fit and accuracy.

### Surface finish max. Ra 0.25

Achieve high clamping force and high transferable torque.

### Balancing

100 % balanced to G 2.5 @ 22,000 rpm.

### Balancing in XL toolholders

100 % balanced to G 2.5 @ 5,000 rpm.

### Hi-Q® balancing system

Ready to accept Hi-Q® balancing rings which allow for the offset of the imbalance introduced by the cutting tool up to 80,000 rpm depending on the balancing rings used. All toolholders with the additional type information "H" in the part number are designed for balancing rings.

### Vibration dampening

Our holders offer good vibration dampening to sustain a high surface finish and can help prevent chatter.

### ID chip hole

In accordance with DIN 69873 for 10 mm diameter.





## SK/PG and SK/PG XL toolholders

### Applications

These toolholders are designed for CNC-machining centers with an automatic tool changer. They are universally suitable for different machining applications. Their vibration dampening reduces spindle wear and extends tool life.

### Balancing

REGO-FIX SK/PG toolholders are balanced to G 2.5 @ 22,000 rpm. Type H toolholders are ready to accept Hi-Q® balancing rings which allow precision balancing of the system including cutting tool up to 80,000 rpm depending on the balancing rings used.

### SK/PG XL available

Due to their good vibration dampening characteristics, SK/PG XL holders are ideally suited in all machining processes where the standard length toolholders cannot be used. All REGO-FIX XL toolholders are balanced to G 2.5 @ 5,000 rpm.

*For more details on our XL toolholders, please refer to page 10.*

### Cooling options

PG standard collets for tools with an internal coolant supply (metallic sealed).  
Coolant flush collets PG-CF for peripheral cooling.

### Matched tooling system for best fit

For highest precision and best results the entire machining system counts. Therefore REGO-FIX components are carefully matched for optimum fit and accuracy. This guarantees the best runout and balance.

*For the influence of runout on tool life, please refer to page 3.*

Type	Part no.	Dimensions [mm]						Accessory
		D	D1	D2	L	L1	L2	FWR ...*
<b>SK 30</b>								
SK 30 / PG 6 x 080 H	4230.70640	10	–	–	80	–	–	225
SK 30 / PG 10 x 060	2230.71020	16	–	–	60	–	–	–
SK 30 / PG 10 x 073 H	4230.71030	16	–	–	73	–	–	285
SK 30 / PG 15 x 060	2230.71520	24	–	–	60	–	–	–
SK 30 / PG 15 x 080 H	4230.71540	24	–	–	80	–	–	285
SK 30 / PG 15 x 120 H	4230.71560	24	–	–	120	–	–	285
SK 30 / PG 25 x 080	2230.72540	40	–	–	80	–	–	–
SK 30 / PG 25 x 160 H	4230.72580	40	–	–	160	–	–	405
<b>SK 40</b>								
SK 40 / PG 10 x 080 H	4240.71040	16	–	–	80	–	–	285
SK 40 / PG 10 x 120 H	4240.71060	16	–	–	120	–	–	285
SK 40 / PG 10 x 160 H	4240.71080	16	–	–	160	–	–	325
SK 40 / PG 10 x 220 XL	8842.71050	16	46	28	220	140	31	–
SK 40 / PG 10 x 260 XL	8842.71090	16	46	28	260	140	31	–
SK 40 / PG 10 x 300 XL	8842.71130	16	46	28	300	140	31	–
SK 40 / PG 10 x 320 XL	8842.71150	16	46	28	320	240	31	–
SK 40 / PG 10 x 360 XL	8842.71190	16	46	28	360	240	31	–
SK 40 / PG 10 x 400 XL	8842.71230	16	46	28	400	240	31	–
SK 40 / PG 15 x 072	2240.71530	24	–	–	72	–	–	–
SK 40 / PG 15 x 080 H	4240.71540	24	–	–	80	–	–	285
SK 40 / PG 15 x 120 H	4240.71560	24	–	–	120	–	–	325
SK 40 / PG 15 x 160 H	4240.71580	24	–	–	160	–	–	325 / 285
SK 40 / PG 15 x 220 XL	8842.73050	24	46	28	220	140	55	–
SK 40 / PG 15 x 260 XL	8842.73090	24	46	28	260	140	55	–
SK 40 / PG 15 x 300 XL	8842.73130	24	46	28	300	140	55	–
SK 40 / PG 15 x 320 XL	8842.73150	24	46	28	320	240	55	–
SK 40 / PG 15 x 360 XL	8842.73190	24	46	28	360	240	55	–
SK 40 / PG 15 x 400 XL	8842.73230	24	46	28	400	240	55	–
SK 40 / PG 25 x 072	2240.72530	40	–	–	72	–	–	–
SK 40 / PG 25 x 080 H	4240.72540	40	–	–	80	–	–	405
SK 40 / PG 25 x 120 H	4240.72560	40	–	–	120	–	–	405
SK 40 / PG 25 x 160 H	4240.72580	40	–	–	160	–	–	405 / 405
SK 40 / PG 25 x 220 XL	8842.76050	40	55	–	220	140	–	–
SK 40 / PG 25 x 320 XL	8842.76150	40	55	–	320	240	–	–
SK 40 / PG 32 x 080	2240.73240	50	–	–	80	–	–	–

\* Balancing rings H: Ready to accept balancing rings

Accessories are not included in delivery.

Other XL sizes available on request.

Type	Part no.	Dimensions [mm]						Accessory
		D	D1	D2	L	L1	L2	FWR ...*
<b>SK-B 40</b>								
SK-B 40 / PG 10 x 080 H	4240.71043	16	–	–	80	–	–	285
SK-B 40 / PG 10 x 120 H	4240.71063	16	–	–	120	–	–	285
SK-B 40 / PG 10 x 160 H	4240.71083	16	–	–	160	–	–	325
SK-B 40 / PG 15 x 072	2240.71533	24	–	–	72	–	–	–
SK-B 40 / PG 15 x 080 H	4240.71543	24	–	–	80	–	–	285
SK-B 40 / PG 15 x 120 H	4240.71563	24	–	–	120	–	–	325
SK-B 40 / PG 15 x 160 H	4240.71583	24	–	–	160	–	–	325 / 285
SK-B 40 / PG 25 x 072	2240.72533	40	–	–	72	–	–	–
SK-B 40 / PG 25 x 080 H	4240.72543	40	–	–	80	–	–	405
SK-B 40 / PG 25 x 120 H	4240.72563	40	–	–	120	–	–	405
SK-B 40 / PG 25 x 160 H	4240.72583	40	–	–	160	–	–	405 / 405
SK-B 40 / PG 32 x 080	2240.73243	50	–	–	80	–	–	–

\* Balancing rings H: Ready to accept balancing rings

Accessories are not included in delivery.

Other XL sizes available on request.

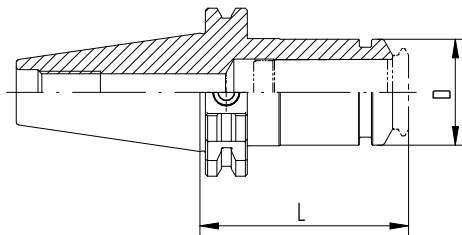

SK/PG (Form A+AD)

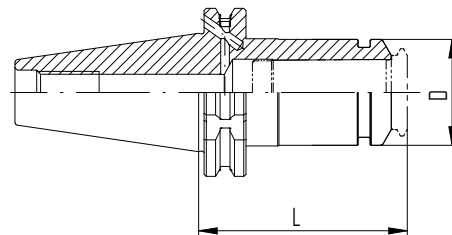

SK-B/PG (Form AD+B)

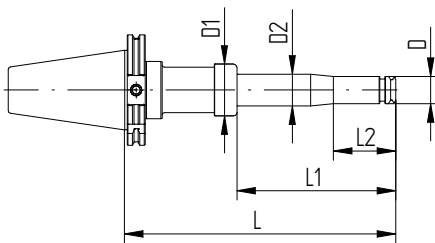

SK/PG XL

# SK toolholders

## SK-B toolholders

SK	SK-B
DIN 69871	DIN 69871
DIN ISO 7388-1	DIN ISO 7388-1

Type	Part no.	Dimensions [mm]						Accessory
		D	D1	D2	L	L1	L2	FWR ...*
<b>SK 50</b>								
SK 50 / PG 10 x 240 XL	8852.71070	16	46	28	240	140	31	–
SK 50 / PG 10 x 300 XL	8852.71130	16	46	28	300	140	31	–
SK 50 / PG 10 x 340 XL	8852.71170	16	46	28	340	240	31	–
SK 50 / PG 10 x 400 XL	8852.71230	16	46	28	400	240	31	–
SK 50 / PG 15 x 240 XL	8852.73070	24	46	28	240	140	55	–
SK 50 / PG 15 x 300 XL	8852.73130	24	46	28	300	140	55	–
SK 50 / PG 15 x 340 XL	8852.73170	24	46	28	340	240	55	–
SK 50 / PG 15 x 400 XL	8852.73230	24	46	28	400	240	55	–
SK 50 / PG 25 x 081	2250.72540	40	–	–	81	–	–	–
SK 50 / PG 25 x 100 H	4250.72550	40	–	–	100	–	–	505
SK 50 / PG 25 x 160 H	4250.72580	40	–	–	160	–	–	505 / 405
SK 50 / PG 25 x 200 H	4250.72590	40	–	–	200	–	–	505 / 405
SK 50 / PG 25 x 320 XL	8852.76150	40	55	–	320	240	–	–
SK 50 / PG 32 x 080	2250.73240	50	–	–	80	–	–	–
SK 50 / PG 32 x 160 H	4250.73280	50	–	–	160	–	–	505
SK 50 / PG 32 x 220 XL	8852.78050	50	58	–	220	140	–	–
SK 50 / PG 32 x 300 XL	8852.78130	50	58	–	300	140	–	–
SK 50 / PG 32 x 320 XL	8852.78150	50	58	–	320	240	–	–
SK 50 / PG 32 x 400 XL	8852.78230	50	58	–	400	240	–	–
<b>SK-B 50</b>								
SK-B 50 / PG 25 x 081	2250.72543	40	–	–	81	–	–	–
SK-B 50 / PG 25 x 100 H	4250.72553	40	–	–	100	–	–	505
SK-B 50 / PG 25 x 160 H	4250.72583	40	–	–	160	–	–	505 / 405
SK-B 50 / PG 25 x 200 H	4250.72593	40	–	–	200	–	–	505 / 405
SK-B 50 / PG 32 x 080	2250.73243	50	–	–	80	–	–	–

\* Balancing rings H: Ready to accept balancing rings

Accessories are not included in delivery.

Other XL sizes available on request.



**We believe in what we do.  
We design and manufacture  
products that meet our passion  
for precision, high quality  
and design.**

Passion for precision

**REGO-FIX** ▲

# BT steep taper toolholders

Universally suitable for different machining applications, the BT interface toolholders cater to different machining needs.

MAS 403 / JIS B 6339 / DIN ISO 7388-2

## Features and benefits

### Total system runout TIR $\leq 0.0001''$ (3 $\mu\text{m}$ )

Our holistic system consists of a powRgrip® toolholder and collet. All components together ensure best runout and accuracy.

### Toolholder runout TIR $\leq 1 \mu\text{m}$

Measured from collet cavity to outer taper.

### Taper accuracy AT3

Better spindle-to-holder fit and accuracy.

### Surface finish max. Ra 0.25

Achieve high clamping force and high transferable torque.

### Balancing

100 % balanced to G 2.5 @ 22,000 rpm.

### Balancing in XL toolholders

100 % balanced to G 2.5 @ 5,000 rpm.

### Hi-Q® balancing system

Ready to accept Hi-Q® balancing rings which allow for the offset of the imbalance introduced by the cutting tool up to 80,000 rpm depending on the balancing rings used. All toolholders with the additional type information "H" in the part number are designed for balancing rings.

### Vibration dampening

Our holders offer good vibration dampening to sustain a high surface finish and can help prevent chatter.

### ID chip hole

In accordance with DIN 69873 for 10 mm diameter.







## BT / PG and BT / PG XL toolholders

### Applications

These toolholders are designed for CNC-machining centers with an automatic tool changer. They are universally suitable for different machining applications. Their vibration dampening reduces spindle wear and extends tool life.

### Balancing

REGO-FIX BT / PG toolholders are balanced to G 2.5 @ 22,000 rpm. Type H toolholders are ready to accept Hi-Q® balancing rings which allow precision balancing of the system including cutting tool up to 80,000 rpm depending on the balancing rings used.

### BT / PG XL available

Due to their good vibration dampening characteristics, BT / PG XL holders are ideally suited in all machining processes where the standard length toolholders cannot be used. All REGO-FIX XL toolholders are balanced to G 2.5 @ 5,000 rpm.

*For more details on our XL toolholders, please refer to page 10.*

### Cooling options

PG standard collets for tools with an internal coolant supply (metallic sealed).  
Coolant flush collets PG-CF for peripheral cooling.

### Matched tooling system for best fit

For highest precision and best results the entire machining system counts. Therefore REGO-FIX components are carefully matched for optimum fit and accuracy. This guarantees the best runout and balance.

*For the influence of runout on tool life, please refer to page 3.*

Type	Part no.	Dimensions [mm]						Accessory
		D	D1	D2	L	L1	L2	FWR ...*
<b>BT 30</b>								
BT 30 / PG 6 x 050	2130.70610	10	–	–	50	–	–	–
BT 30 / PG 6 x 080 H	4130.70640	10	–	–	80	–	–	225
BT 30 / PG 10 x 062	2130.71020	16	–	–	62	–	–	–
BT 30 / PG 10 x 080 H	4130.71040	16	–	–	80	–	–	285
BT 30 / PG 10 x 120 H	4130.71060	16	–	–	120	–	–	285
BT 30 / PG 10 x 160 H	4130.71080	16	–	–	160	–	–	285
BT 30 / PG 15 x 065	2130.71520	24	–	–	65	–	–	–
BT 30 / PG 15 x 070 H	4130.71530	24	–	–	70	–	–	285
BT 30 / PG 15 x 120 H	4130.71560	24	–	–	120	–	–	285
BT 30 / PG 25 x 075	2130.72530	40	–	–	75	–	–	–
BT 30 / PG 25 x 080 H	4130.72540	40	–	–	80	–	–	405
•BT 30 / PG 25 x 080 H with No Drive Slot	8020.21000	40	–	–	80	–	–	405
BT 30 / PG 25 x 120 H	4130.72560	40	–	–	120	–	–	405
BT 30 / PG 25 x 160 H	4130.72580	40	–	–	160	–	–	405 / 405

\* Balancing rings H: Ready to accept balancing rings

Accessories are not included in delivery.

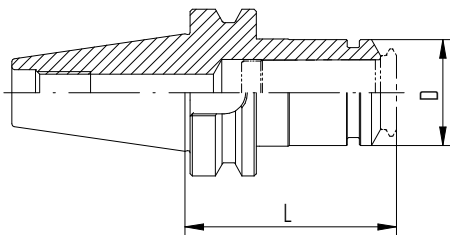

BT / PG

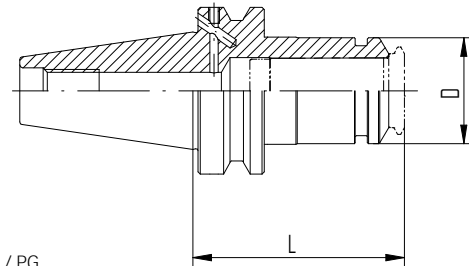

BT-B / PG

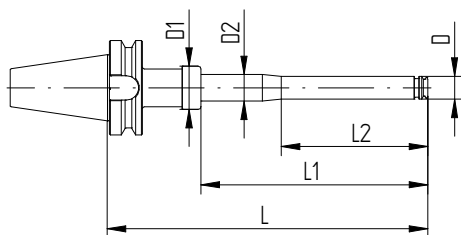

BT / PG XL

# BT toolholders

## BT-B toolholders

BT	BT-B
MAS 403	MAS 403
JIS B 6339	JIS B 6339
DIN ISO 7388-2	DIN ISO 7388-2

Type	Part no.	Dimensions [mm]						Accessory
		D	D1	D2	L	L1	L2	FWR ...*
<b>BT 40</b>								
BT 40 / PG 10 x 080 H	4140.71040	16	–	–	80	–	–	285
BT 40 / PG 10 x 120 H	4140.71060	16	–	–	120	–	–	325
BT 40 / PG 10 x 160 H	4140.71080	16	–	–	160	–	–	325
BT 40 / PG 10 x 220 XL	8841.71050	16	46	28	220	140	31	–
BT 40 / PG 10 x 260 XL	8841.71090	16	46	28	260	140	31	–
BT 40 / PG 10 x 300 XL	8841.71130	16	46	28	300	140	31	–
BT 40 / PG 10 x 320 XL	8841.71150	16	46	28	320	240	31	–
BT 40 / PG 10 x 360 XL	8841.71190	16	46	28	360	240	31	–
BT 40 / PG 10 x 400 XL	8841.71230	16	46	28	400	240	31	–
BT 40 / PG 15 x 075	2140.71530	24	–	–	75	–	–	–
BT 40 / PG 15 x 080 H	4140.71540	24	–	–	80	–	–	285
BT 40 / PG 15 x 120 H	4140.71560	24	–	–	120	–	–	325
BT 40 / PG 15 x 160 H	4140.71580	24	–	–	160	–	–	325 / 285
BT 40 / PG 15 x 220 XL	8841.73050	24	46	28	220	140	55	–
BT 40 / PG 15 x 260 XL	8841.73090	24	46	28	260	140	55	–
BT 40 / PG 15 x 300 XL	8841.73130	24	46	28	300	140	55	–
BT 40 / PG 15 x 320 XL	8841.73150	24	46	28	320	240	55	–
BT 40 / PG 15 x 360 XL	8841.73190	24	46	28	360	240	55	–
BT 40 / PG 15 x 400 XL	8841.73230	24	46	28	400	240	55	–
BT 40 / PG 25 x 080 H	4140.72540	40	–	–	80	–	–	405
BT 40 / PG 25 x 120 H	4140.72560	40	–	–	120	–	–	405
BT 40 / PG 25 x 160 H	4140.72580	40	–	–	160	–	–	405 / 405
BT 40 / PG 25 x 226 XL	8841.76050	40	55	–	226	140	–	–
BT 40 / PG 25 x 326 XL	8841.76150	40	55	–	326	240	–	–
BT 40 / PG 32 x 086	2140.73240	50	–	–	86	–	–	–
<b>BT-B 40</b>								
BT-B 40 / PG 10 x 080 H	4140.71043	16	–	–	80	–	–	285
BT-B 40 / PG 10 x 120 H	4140.71063	16	–	–	120	–	–	325
BT-B 40 / PG 10 x 160 H	4140.71083	16	–	–	160	–	–	325
BT-B 40 / PG 15 x 075	2140.71533	24	–	–	75	–	–	–
BT-B 40 / PG 15 x 080 H	4140.71543	24	–	–	80	–	–	285
BT-B 40 / PG 15 x 120 H	4140.71563	24	–	–	120	–	–	325
BT-B 40 / PG 15 x 160 H	4140.71583	24	–	–	160	–	–	325 / 285
BT-B 40 / PG 25 x 080 H	4140.72543	40	–	–	80	–	–	405
BT-B 40 / PG 25 x 120 H	4140.72563	40	–	–	120	–	–	405
BT-B 40 / PG 25 x 160 H	4140.72583	40	–	–	160	–	–	405 / 405
BT-B 40 / PG 32 x 086	2140.73243	50	–	–	86	–	–	–

\* Balancing rings H: Ready to accept balancing rings

Accessories are not included in delivery.

Other XL sizes available on request.

Type	Part no.	Dimensions [mm]						Accessory
		D	D1	D2	L	L1	L2	FWR ...*
<b>BT 50</b>								
BT 50 / PG 10 x 120 H	4150.71060	16	-	-	120	-	-	405
BT 50 / PG 10 x 160 H	4150.71080	16	-	-	160	-	-	405
BT 50 / PG 10 x 240 XL	8851.71070	16	46	28	240	140	31	-
BT 50 / PG 10 x 260 XL	8851.71090	16	46	28	260	140	31	-
BT 50 / PG 10 x 300 XL	8851.71130	16	46	28	300	140	31	-
BT 50 / PG 10 x 340 XL	8851.71170	16	46	28	340	240	31	-
BT 50 / PG 10 x 360 XL	8851.71190	16	46	28	360	240	31	-
BT 50 / PG 10 x 400 XL	8851.71230	16	46	28	400	240	31	-
BT 50 / PG 15 x 120 H	4150.71560	24	-	-	120	-	-	325
BT 50 / PG 15 x 160 H	4150.71580	24	-	-	160	-	-	325
BT 50 / PG 15 x 240 XL	8851.73070	24	46	28	240	140	55	-
BT 50 / PG 15 x 260 XL	8851.73090	24	46	28	260	140	55	-
BT 50 / PG 15 x 300 XL	8851.73130	24	46	28	300	140	55	-
BT 50 / PG 15 x 340 XL	8851.73170	24	46	28	340	240	55	-
BT 50 / PG 15 x 360 XL	8851.73190	24	46	28	360	240	55	-
BT 50 / PG 15 x 400 XL	8851.73230	24	46	28	400	240	55	-
BT 50 / PG 25 x 100	2150.72550	40	-	-	100	-	-	-
BT 50 / PG 25 x 120 H	4150.72560	40	-	-	120	-	-	505
BT 50 / PG 25 x 160 H	4150.72580	40	-	-	160	-	-	505 / 405
BT 50 / PG 25 x 200 H	4150.72590	40	-	-	200	-	-	505 / 405
BT 50 / PG 25 x 240 XL	8851.76070	40	55	-	240	140	-	-
BT 50 / PG 25 x 340 XL	8851.76170	40	55	-	340	240	-	-
BT 50 / PG 32 x 100	2150.73250	50	-	-	100	-	-	-
BT 50 / PG 32 x 240 XL	8851.78070	50	58	-	240	140	-	-
BT 50 / PG 32 x 340 XL	8851.78170	50	58	-	340	240	-	-

\* Balancing rings H: Ready to accept balancing rings

Accessories are not included in delivery.

Other XL sizes available on request.

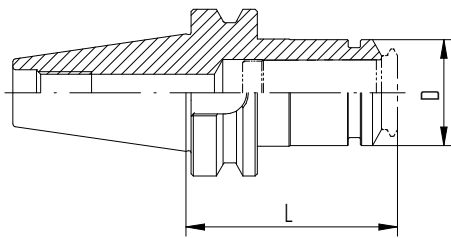

BT / PG

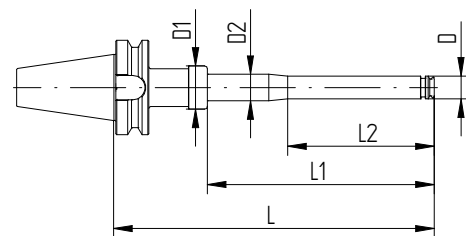

BT / PG XL

## BT-OM toolholders

Type	Part no.	Dimensions [mm]				Accessory
		D	D1	L	L1	FWR ...*
<b>BT-OM</b>						
BT-OM 30 / PG 10 x 062	2130.71028	16	–	62	–	–
BT-OM 30 / PG 15 x 070 H	4130.71538	24	–	70	–	285
BT-OM 30 / PG 25 x 080 H	4130.72548	40	–	80	–	405

\* Balancing rings H: Ready to accept balancing rings

Accessories are not included in delivery.

### Information

## BT-OM/PG toolholders without drive slots

### Applications

This special toolholder without drive slots is designed for use on HAAS and HURCO CNC-machining centers, for High Speed Cutting (HSC) and High Performance Cutting (HPC). Use up to the max. power limit of the processing machine.

The anti-vibration characteristics of the BT-OM / PG toolholder reduce the wear of spindle and tool.

### Balancing

REGO-FIX BT-OM / PG toolholders are balanced to G 2.5 @ 22,000 rpm. Type H toolholders are compatible with Hi-Q® balancing rings which allow precision balancing of the entire system including cutting tool up to 80,000 rpm depending on the balancing rings used.

### Cooling options

PG standard collets for tools with an internal coolant supply (metallic sealed).  
Coolant flush collets PG-CF for peripheral cooling.

### Matched tooling system for best fit

For highest precision and best results the entire machining system counts. Therefore REGO-FIX components are carefully matched for optimum fit and accuracy. This guarantees the best runout and balance.

*For the influence of runout on tool life, please refer to page 3.*

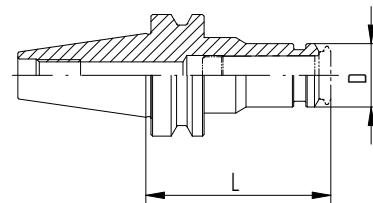

BT-OM / PG

# BT+ REGO PLUS dual contact toolholders

**Certified** The BIG PLUS SYSTEM – licensed by BIG Daishowa – is manufactured at REGO-FIX in Switzerland under license according to BIG PLUS specifications.

## Key advantages

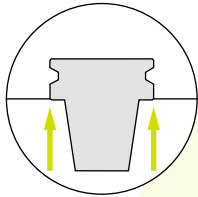

Higher toolholder stiffness due to taper (AT1) and face contact.

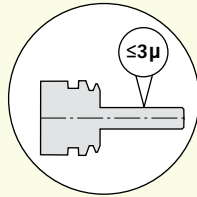

Total system runout TIR  $\leq 3 \mu\text{m}$  at  $3 \times D$ .

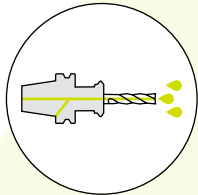

Form AD+B as standard configuration.



Type	Part no.	Dimensions [mm]		Accessory
		D	D1	FWR ...*
<b>BT+ 30</b>				
BT+ 30 / PG 10 x 080 H	4130.71046	16	80	285
BT+ 30 / PG 15 x 070 H	4130.71536	24	70	285
BT+ 30 / PG 25 x 080 H	4130.72546	40	80	405
BT+ 30 / PG 25 x 160 H	4130.72586	40	160	405 / 405
<b>BT+ 40</b>				
BT+ 40 / PG 10 x 080 H	4140.71046	16	80	285
BT+ 40 / PG 10 x 120 H	4140.71066	16	120	325
BT+ 40 / PG 15 x 080 H	4140.71546	24	80	285
BT+ 40 / PG 15 x 120 H	4140.71566	24	120	325
BT+ 40 / PG 25 x 080 H	4140.72546	40	80	405
BT+ 40 / PG 25 x 120 H	4140.72566	40	120	405
BT+ 40 / PG 25 x 160 H	4140.72586	40	160	405 / 405
<b>BT+ 50</b>				
BT+ 50 / PG 25 x 120 H	4150.72566	40	120	505
BT+ 50 / PG 25 x 160 H	4150.72586	40	160	505 / 405

\* Balancing rings H: Ready to accept balancing rings

Accessories are not included in delivery.

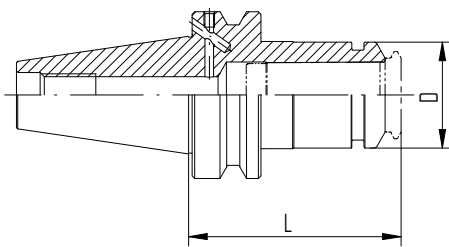

BT+ / PG

# HSK toolholders

Designed for rotating applications, all our HSK toolholders are suited for high-speed applications where consistent performance is key.

DIN 69893 / ISO 12164

## Features and benefits

### Total system runout TIR $\leq 0.0001''$ (3 $\mu\text{m}$ )

Our holistic system consists of a powRgrip® toolholder and collet. All components together ensure best runout and accuracy.

### Toolholder runout TIR $\leq 1 \mu\text{m}$

Measured from collet cavity to outer taper.

### Surface finish max. Ra 0.25

Achieve high clamping force and high transferable torque.

### Hi-Q® balancing system

REGO-FIX HSK / PG toolholders are balanced to G 2.5 @ 25,000 rpm. Type H toolholders are ready to accept Hi-Q® balancing rings which allow precision-balancing of the system including cutting tool up to 80,000 rpm depending on the balancing rings used.

### Balancing in XL toolholders

100% balanced to G 2.5 @ 5,000 rpm.

### Vibration dampening

Our holders offer a good vibration dampening to sustain a high surface finish and can prevent cutting force alterations.

### Matched tooling system for best fit

For highest precision and best results the entire machining system counts. Therefore our components are carefully matched for optimum fit and accuracy. This guarantees the best runout and balance.

### ID chip hole (only HSK form A+B)

In accordance with DIN 69873 for 10 mm diameter.

### Expert advice

For all HSK-A and HSK-E form toolholders a range of coolant tubes (KSR) is available.

*For KSR part numbers please refer to page 85.*





# HSK forms and their key characteristics

HSK

DIN 69893

ISO 12164

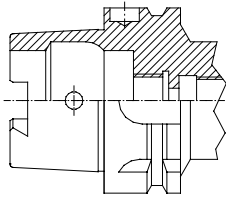

## Form A\*

- // Standard type for machining centers and milling machines
- // For automatic tool change
- // Coolant supply through center via coolant tube
- // Drive keys at the end of HSK taper
- // Hole for data carrier DIN STD 69873 in the flange

\* Also usable in form C applications with side hole for manual tool change.

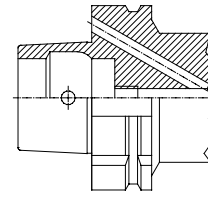

## Form B

- // For machining centers, milling and turning machines
- // With enlarged flange size for higher radial rigidity
- // For automatic tool change
- // Coolant supply through the flange
- // Drive keys at the flange
- // Hole for data carrier DIN STD 69873 at the flange

Available on request.

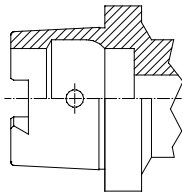

## Form C

- // For transfer lines, special machines and modular tooling systems
- // For manual tool change
- // Drive keys at the end of HSK taper

Available on request.

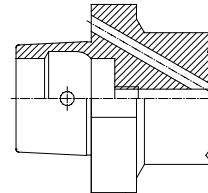

## Form D

- // For special machines
- // With enlarged flange size for higher radial rigidity
- // For manual tool change
- // Coolant supply through the flange
- // Drive keys at the flange

Available on request.

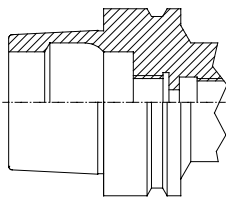

## Form E

- // For high-speed applications
- // For automatic tool change
- // Coolant supply through center via coolant tube
- // Without any drive keys for absolute symmetry

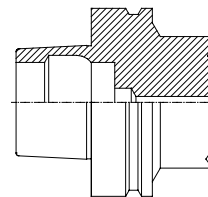

## Form F

- // For high-speed applications
- // For automatic tool change
- // With enlarged flange size for higher radial rigidity
- // Without any drive keys for absolute symmetry

Type	Part no.	Dimensions [mm]						Accessory
		D	D1	D2	L	L1	L2	FWR ...*
<b>HSK-A 32</b>								
HSK-A 32 / PG 10 x 060	2532.71020	16	–	–	60	–	–	–
HSK-A 32 / PG 15 x 075	2532.71530	24	–	–	75	–	–	–
<b>HSK-A 40</b>								
HSK-A 40 / PG 6 x 048	2540.70610	10	–	–	48	–	–	–
HSK-A 40 / PG 6 x 080 H	4540.70640	10	–	–	80	–	–	225
HSK-A 40 / PG 10 x 062	2540.71020	16	–	–	62	–	–	–
HSK-A 40 / PG 10 x 080 H	4540.71040	16	–	–	80	–	–	225
HSK-A 40 / PG 15 x 074	2540.71530	24	–	–	74	–	–	–
HSK-A 40 / PG 15 x 080 H	4540.71540	24	–	–	80	–	–	285
HSK-A 40 / PG 25 x 090	2540.72540	40	–	–	90	–	–	–
HSK-A 40 / PG 25 x 100 H	4540.72550	40	–	–	100	–	–	405
<b>HSK-A 50</b>								
HSK-A 50 / PG 10 x 080 H	4550.71040	16	–	–	80	–	–	285
HSK-A 50 / PG 10 x 120 H	4550.71060	16	–	–	120	–	–	285
HSK-A 50 / PG 15 x 080 H	4550.71540	24	–	–	80	–	–	285
HSK-A 50 / PG 25 x 100 H	4550.72550	40	–	–	100	–	–	405
<b>HSK-A 63</b>								
HSK-A 63 / PG 6 x 080 H	4563.70640	10	–	–	80	–	–	225
HSK-A 63 / PG 10 x 080 H	4563.71040	16	–	–	80	–	–	325
HSK-A 63 / PG 10 x 120 H	4563.71060	16	–	–	120	–	–	325
HSK-A 63 / PG 10 x 160 H	4563.71080	16	–	–	160	–	–	325
HSK-A 63 / PG 10 x 200 H	4563.71090	16	–	–	200	–	–	325
HSK-A 63 / PG 10 x 240 XL	8865.71070	16	46	28	240	140	31	–
HSK-A 63 / PG 10 x 260 XL	8865.71090	16	46	28	260	140	31	–
HSK-A 63 / PG 10 x 300 XL	8865.71130	16	46	28	300	140	31	–
HSK-A 63 / PG 10 x 340 XL	8865.71170	16	46	28	340	240	31	–
HSK-A 63 / PG 10 x 360 XL	8865.71190	16	46	28	360	240	31	–
HSK-A 63 / PG 10 x 400 XL	8865.71230	16	46	28	400	240	31	–
HSK-A 63 / PG 15 x 080 H	4563.71540	24	–	–	80	–	–	325
HSK-A 63 / PG 15 x 120 H	4563.71560	24	–	–	120	–	–	325
HSK-A 63 / PG 15 x 160 H	4563.71580	24	–	–	160	–	–	325 / 285
HSK-A 63 / PG 15 x 240 XL	8865.73070	24	46	28	240	140	55	–

\* Balancing rings H: Ready to accept balancing rings

Accessories are not included in delivery.

Other XL sizes available on request.

Type	Part no.	Dimensions [mm]						Accessory
		D	D1	D2	L	L1	L2	FWR ...*
HSK-A 63 / PG 15 x 260 XL	8865.73090	24	46	28	260	140	55	–
HSK-A 63 / PG 15 x 300 XL	8865.73130	24	46	28	300	140	55	–
HSK-A 63 / PG 15 x 340 XL	8865.73170	24	46	28	340	240	55	–
HSK-A 63 / PG 15 x 360 XL	8865.73190	24	46	28	360	240	55	–
HSK-A 63 / PG 15 x 400 XL	8865.73230	24	46	28	400	240	55	–
HSK-A 63 / PG 25 x 100 H	4563.72550	40	–	–	100	–	–	405
HSK-A 63 / PG 25 x 120 H	4563.72560	40	–	–	120	–	–	405
HSK-A 63 / PG 25 x 160 H	4563.72580	40	–	–	160	–	–	405 / 405
HSK-A 63 / PG 25 x 200 H	4563.72590	40	–	–	200	–	–	405 / 405
HSK-A 63 / PG 25 x 240 XL	8865.76070	40	55	–	240	140	–	–
HSK-A 63 / PG 25 x 260 XL	8865.76090	40	55	–	260	140	–	–
HSK-A 63 / PG 25 x 340 XL	8865.76170	40	55	–	340	240	–	–
HSK-A 63 / PG 25 x 360 XL	8865.76190	40	55	–	360	240	–	–
HSK-A 63 / PG 32 x 100	2563.73250	50	–	–	100	–	–	–
HSK-A 63 / PG 32 x 120 H	4563.73260	50	–	–	120	–	–	505
HSK-A 63 / PG 32 x 240 XL	8865.78070	50	58	–	240	140	–	–
HSK-A 63 / PG 32 x 260 XL	8865.78090	50	58	–	260	140	–	–
HSK-A 63 / PG 32 x 340 XL	8865.78170	50	58	–	340	240	–	–
HSK-A 63 / PG 32 x 360 XL	8865.76190	50	58	–	360	240	–	–

## HSK-A 80

HSK-A 80 / PG 15 x 085 H	4580.71540	24	–	–	85	–	–	325
HSK-A 80 / PG 25 x 100 H	4580.72550	40	–	–	100	–	–	505
HSK-A 80 / PG 32 x 105 H	4580.73250	50	–	–	105	–	–	505

\* Balancing rings H: Ready to accept balancing rings

Accessories are not included in delivery.

Other XL sizes available on request.

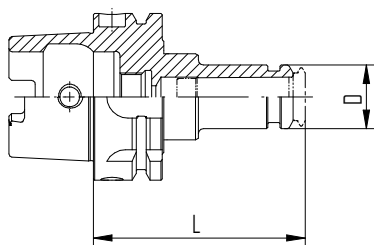

HSK-A / PG

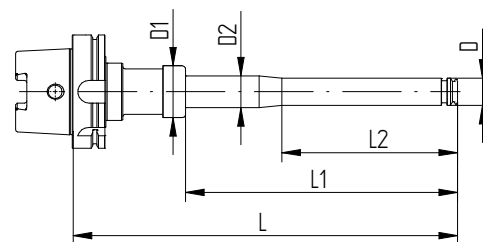

HSK-A / PG XL

Type	Part no.	Dimensions [mm]						Accessory
		D	D1	D2	L	L1	L2	FWR ...*
<b>HSK-A 100</b>								
HSK-A 100 / PG 10 x 085 H	4500.71040	16	–	–	85	–	–	405
HSK-A 100 / PG 10 x 160 H	4500.71080	16	–	–	160	–	–	405
HSK-A 100 / PG 10 x 240 XL	8885.71070	16	46	28	240	140	31	–
HSK-A 100 / PG 10 x 300 XL	8885.71130	16	46	28	300	140	31	–
HSK-A 100 / PG 10 x 340 XL	8885.71170	16	46	28	340	240	31	–
HSK-A 100 / PG 10 x 400 XL	8885.71230	16	46	28	400	240	31	–
HSK-A 100 / PG 15 x 085 H	4500.71540	24	–	–	85	–	–	405
HSK-A 100 / PG 15 x 160 H	4500.71580	24	–	–	160	–	–	405 / 285
HSK-A 100 / PG 15 x 240 XL	8885.73070	24	46	28	240	140	55	–
HSK-A 100 / PG 15 x 300 XL	8885.73110	24	46	28	300	140	55	–
HSK-A 100 / PG 15 x 340 XL	8885.73170	24	46	28	340	240	55	–
HSK-A 100 / PG 15 x 400 XL	8885.73230	24	46	28	400	240	55	–
HSK-A 100 / PG 25 x 100 H	4500.72550	40	–	–	100	–	–	505
HSK-A 100 / PG 25 x 120 H	4500.72560	40	–	–	120	–	–	505
HSK-A 100 / PG 25 x 160 H	4500.72580	40	–	–	160	–	–	505 / 405
HSK-A 100 / PG 25 x 200 H	4500.72590	40	–	–	200	–	–	505 / 405
HSK-A 100 / PG 25 x 246 XL	8885.76070	40	55	–	246	140	–	–
HSK-A 100 / PG 25 x 346 XL	8885.76170	40	55	–	346	240	–	–
HSK-A 100 / PG 32 x 106 H	4500.73250	50	–	–	106	–	–	505
HSK-A 100 / PG 32 x 120 H	4500.73260	50	–	–	120	–	–	505
HSK-A 100 / PG 32 x 160 H	4500.73280	50	–	–	160	–	–	505
HSK-A 100 / PG 32 x 200 H	4500.73290	50	–	–	200	–	–	505 / 505
HSK-A 100 / PG 32 x 246 XL	8885.78070	50	58	–	246	140	–	–
HSK-A 100 / PG 32 x 260 XL	8885.78090	50	58	–	260	140	–	–
HSK-A 100 / PG 32 x 300 XL	8885.78130	50	58	–	300	140	–	–
HSK-A 100 / PG 32 x 340 XL	8885.78170	50	58	–	340	140	–	–
HSK-A 100 / PG 32 x 360 XL	8885.78190	50	58	–	360	240	–	–
HSK-A 100 / PG 32 x 400 XL	8885.78230	50	58	–	400	240	–	–
HSK-A 100 / PG 32 x 440 XL	8885.78270	50	58	–	440	240	–	–

\* Balancing rings H: Ready to accept balancing rings

Accessories are not included in delivery. Other XL sizes available on request.

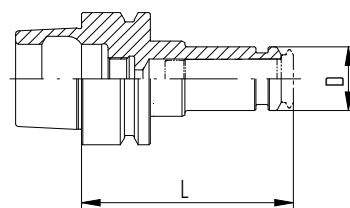

HSK-E / PG

Type	Part no.	Dimensions [mm]						Accessory
		D	D1	D2	L	L1	L2	FWR ...*
<b>HSK-E 25</b>								
HSK-E 25 / PG 6 x 043	2525.70614	10	-	-	43	-	-	-
HSK-E 25 / PG 10 x 055	2525.71014	16	-	-	55	-	-	-
<b>HSK-E 32</b>								
HSK-E 32 / PG 6 x 048	2532.70614	10	-	-	48	-	-	-
HSK-E 32 / PG 6 x 080	2532.70644	10	-	-	80	-	-	-
HSK-E 32 / PG 10 x 060	2532.71024	16	-	-	60	-	-	-
HSK-E 32 / PG 10 x 080	2532.71044	16	-	-	80	-	-	-
HSK-E 32 / PG 10 x 080 H	4532.71044	16	-	-	80	-	-	225
HSK-E 32 / PG 15 x 075	2532.71534	24	-	-	75	-	-	-
<b>HSK-E 40</b>								
HSK-E 40 / PG 6 x 048	2540.70614	10	-	-	48	-	-	-
HSK-E 40 / PG 6 x 080 H	4540.70644	10	-	-	80	-	-	225
HSK-E 40 WM / PG 10 x 052+	2540.71017	16	-	-	52	-	-	-
HSK-E 40 WM / PG 10 x 062	2540.71027	16	-	-	62	-	-	-
HSK-E 40 / PG 10 x 062	2540.71024	16	-	-	62	-	-	-
HSK-E 40 WM / PG 10 x 080 H	4540.71047	16	-	-	80	-	-	225
HSK-E 40 / PG 10 x 080 H	4540.71044	16	-	-	80	-	-	225
HSK-E 40 / PG 10 x 120 H	4540.71064	16	-	-	120	-	-	225
HSK-E 40 / PG 10 x 160 H	4540.71084	16	-	-	160	-	-	285
HSK-E 40 WM / PG 15 x 064+	2540.71527	16	-	-	64	-	-	-
HSK-E 40 / PG 15 x 074	2540.71534	24	-	-	74	-	-	-
HSK-E 40 WM / PG 15 x 080 H	4540.71547	24	-	-	80	-	-	285
HSK-E 40 / PG 15 x 080 H	4540.71544	24	-	-	80	-	-	285
HSK-E 40 / PG 15 x 120 H	4540.71564	24	-	-	120	-	-	285
HSK-E 40 / PG 25 x 090	2540.72544	40	-	-	90	-	-	-
HSK-E 40 / PG 25 x 100 H	4540.72554	40	-	-	100	-	-	405
<b>HSK-E 50</b>								
HSK-E 50 / PG 6 x 080 H	4550.70644	10	-	-	80	-	-	225
HSK-E 50 / PG 10 x 067	2550.71024	16	-	-	67	-	-	-
HSK-E 50 / PG 10 x 080 H	4550.71044	16	-	-	80	-	-	285
HSK-E 50 / PG 10 x 120 H	4550.71064	16	-	-	120	-	-	285
HSK-E 50 / PG 10 x 160 H	4550.71084	16	-	-	160	-	-	285
HSK-E 50 / PG 15 x 080 H	4550.71544	24	-	-	80	-	-	285
HSK-E 50 / PG 15 x 120 H	4550.71564	24	-	-	120	-	-	285
HSK-E 50 / PG 25 x 100 H	4550.72554	40	-	-	100	-	-	405

\* Balancing rings H: Ready to accept balancing rings + without coolant tube threads WM: Willemin-Macodel compatible Accessories are not included in delivery.

Type	Part no.	Dimensions [mm]						Accessory
		D	D1	D2	L	L1	L2	FWR ...*
<b>HSK-E 63</b>								
HSK-E 63 / PG 15 x 080 H	4563.71544	24	–	–	80	–	–	325
HSK-E 63 / PG 25 x 100 H	4563.72554	40	–	–	100	–	–	405
<b>HSK-F 63</b>								
HSK-F 63 / PG 10 x 080 H	4563.71045	16	–	–	80	–	–	325
HSK-F 63 / PG 10 x 120 H	4563.71065	16	–	–	120	–	–	325
HSK-F 63 / PG 10 x 160 H	4563.71085	16	–	–	160	–	–	325
HSK-F 63 / PG 15 x 080 H	4563.71545	24	–	–	80	–	–	325
HSK-F 63 / PG 15 x 120 H	4563.71565	24	–	–	120	–	–	325
HSK-F 63 / PG 15 x 160 H	4563.71585	24	–	–	160	–	–	325 / 285
HSK-F 63 / PG 25 x 100 H	4563.72555	40	–	–	100	–	–	405
HSK-F 63 / PG 25 x 160 H	4563.72585	40	–	–	160	–	–	405
HSK-F 63 / PG 32 x 100	2563.73255	50	–	–	100	–	–	–
<b>HSK-FP 80</b>								
HSK-FP 80 / PG 25 x 90 H	8020.13200	40	–	–	90	–	–	405
HSK-FP 80 / PG 32 x 100 H	8020.13100	50	–	–	100	–	–	505

### HSK-F 80

Call for availability 800-999-7346

Accessories are not included in delivery.

\* Balancing rings H: Ready to accept balancing rings

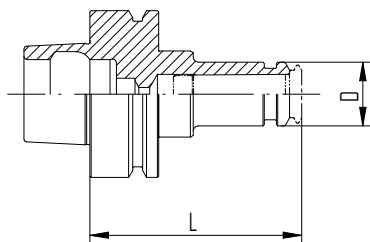

HSK-F / PG



# REGO-FIX CAPTO toolholders

These self-centering and balanced toolholders enable high-torque transmission and show a high-bending strength.

ISO 12164

## Features and benefits

### Total system runout TIR $\leq 0.0001''$ (3 $\mu\text{m}$ )

Our holistic system consists of a powRgrip® toolholder and collet. All components together ensure best runout and accuracy.

### Toolholder runout TIR $\leq 1 \mu\text{m}$

Measured from collet cavity to outer taper.

### Surface finish max. Ra 0.25

Achieve high clamping force and high transferable torque.

### Balancing

100 % balanced to G 2.5 @ 25,000 rpm.

### Balancing in XL toolholders

100 % balanced to G 2.5 @ 5,000 rpm.

### Hi-Q® balancing system

Ready to accept Hi-Q® balancing rings which allow for the offset of the imbalance introduced by the cutting tool up to 80,000 rpm depending on the balancing rings used. All toolholders with the additional type information "H" in the part number are designed for balancing rings.

### Vibration dampening

Our holders offer good vibration dampening to sustain a high surface finish and can prevent cutting force alterations.

**Certified** REGO-FIX CAPTO – licensed by Sandvik Coromant – is manufactured at REGO-FIX Switzerland under license according to CAPTO specifications.

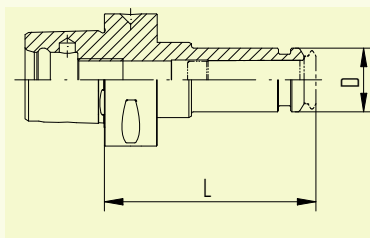

C/PG

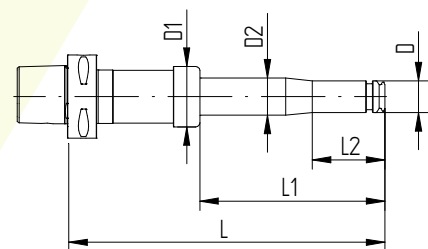

C/PG XL



Type	Part no.	Dimensions [mm]						Accessory
		D	D1	D2	L	L1	L2	FWR ...*
<b>C3</b>								
C3 / PG 6 x 045	2803.70610	10	–	–	45	–	–	–
C3 / PG 10 x 055	2803.71010	16	–	–	55	–	–	–
<b>C4</b>								
C4 / PG 6 x 048	2804.70610	10	–	–	48	–	–	–
C4 / PG 10 x 060	2804.71020	16	–	–	60	–	–	–
C4 / PG 10 x 080 H	4804.71040	16	–	–	80	–	–	225
C4 / PG 15 x 062	2804.71520	24	–	–	62	–	–	–
C4 / PG 15 x 080 H	4804.71540	24	–	–	80	–	–	285
<b>C5</b>								
C5 / PG 6 x 080 H	4805.70640	10	–	–	80	–	–	225
C5 / PG 10 x 060	2805.71020	16	–	–	60	–	–	–
C5 / PG 10 x 080 H	4805.71040	16	–	–	80	–	–	285
C5 / PG 10 x 120 H	4805.71060	16	–	–	120	–	–	285
C5 / PG 15 x 065	2805.71520	24	–	–	65	–	–	–
C5 / PG 15 x 080 H	4805.71540	24	–	–	80	–	–	285
C5 / PG 15 x 120 H	4805.71560	24	–	–	120	–	–	325
C5 / PG 25 x 80	2805.72540	40	–	–	80	–	–	–
C5 / PG 25 x 100 H	4805.72550	40	–	–	100	–	–	405
<b>C6</b>								
C6 / PG 10 x 070	2806.71030	16	–	–	70	–	–	–
C6 / PG 10 x 080 H	4806.71040	16	–	–	80	–	–	325
C6 / PG 10 x 120 H	4806.71060	16	–	–	120	–	–	325
C6 / PG 10 x 160 H	4806.71080	16	–	–	160	–	–	325
C6 / PG 10 x 225 XL	8886.71050	16	46	28	225	140	31	–
C6 / PG 10 x 240 XL	8886.71070	16	46	28	240	140	31	–
C6 / PG 10 x 260 XL	8886.71090	16	46	28	260	140	31	–
C6 / PG 10 x 300 XL	8886.71130	16	46	28	300	140	31	–
C6 / PG 10 x 325 XL	8886.71150	16	46	28	325	240	31	–
C6 / PG 10 x 340 XL	8886.71170	16	46	28	340	240	31	–
C6 / PG 10 x 360 XL	8886.71190	16	46	28	360	240	31	–
C6 / PG 10 x 400 XL	8886.71230	16	46	28	400	240	31	–

\* Balancing rings H: Ready to accept balancing rings

Accessories are not included in delivery.

Other XL sizes available on request.

Type	Part no.	Dimensions [mm]						Accessory
		D	D1	D2	L	L1	L2	FWR ...*
C6 / PG 15 x 071	2806.71530	24	–	–	71	–	–	–
C6 / PG 15 x 080 H	4806.71540	24	–	–	80	–	–	325
C6 / PG 15 x 120 H	4806.71560	24	–	–	120	–	–	325
C6 / PG 15 x 160 H	4806.71580	24	–	–	160	–	–	325
C6 / PG 15 x 225 XL	8886.73050	24	46	28	225	140	55	–
C6 / PG 15 x 240 XL	8886.73070	24	46	28	240	140	55	–
C6 / PG 15 x 260 XL	8886.73090	24	46	28	260	140	55	–
C6 / PG 15 x 300 XL	8886.73130	24	46	28	300	140	55	–
C6 / PG 15 x 325 XL	8886.73150	24	46	28	325	240	55	–
C6 / PG 15 x 340 XL	8886.73170	24	46	28	340	240	55	–
C6 / PG 15 x 360 XL	8886.73190	24	46	28	360	240	55	–
C6 / PG 15 x 400 XL	8886.73230	24	46	28	400	240	55	–
C6 / PG 25 x 085	2806.72540	40	–	–	85	–	–	–
C6 / PG 25 x 100 H	4806.72550	40	–	–	100	–	–	405
C6 / PG 25 x 120 H	4806.72560	40	–	–	120	–	–	405
C6 / PG 25 x 160 H	4806.72580	40	–	–	160	–	–	405
C6 / PG 25 x 230 XL	8886.76060	40	55	–	230	140	–	–
C6 / PG 25 x 330 XL	8886.76160	40	55	–	330	240	–	–
C6 / PG 32 x 090	2806.73240	50	–	–	90	–	–	–

C8								
C8 / PG 10 x 232 XL	8888.71060	16	46	28	232	140	31	–
C8 / PG 10 x 332 XL	8888.71160	16	46	28	332	240	31	–
C8 / PG 15 x 232 XL	8888.73060	24	46	28	232	140	55	–
C8 / PG 15 x 332 XL	8888.73160	24	46	28	332	240	55	–
C8 / PG 25 x 092	2808.72540	40	–	–	92	–	–	–
C8 / PG 25 x 230 XL	8888.76060	40	55	–	230	140	–	–
C8 / PG 25 x 330 XL	8888.76160	40	55	–	330	240	–	–
C8 / PG 32 x 090	2808.73240	50	–	–	90	–	–	–

\* Balancing rings H: Ready to accept balancing rings

Accessories are not included in delivery.

Other XL sizes available on request.

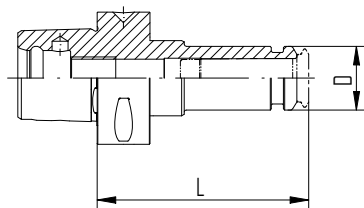

C/PG

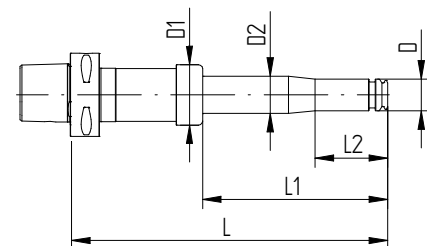

C/PG XL



# Cylindrical shank toolholders CYL

CYL

## Features and benefits

**Total system runout TIR  $\leq 0.0001''$  (3  $\mu\text{m}$ )**

Our holistic system consists of a powRgrip® toolholder and collet. All components together ensure best runout and accuracy.

**Toolholder runout TIR  $\leq 1 \mu\text{m}$**

Measured from collet cavity to outer shank.

**Surface finish max. Ra 0.25**

Achieve high clamping force and high transferable torque.

**Minimal outside dimensions**

Slim design provides more machining flexibility.

**Extra length possible**

CYL 10/PG and CYL 20/PG can be used as extensions.

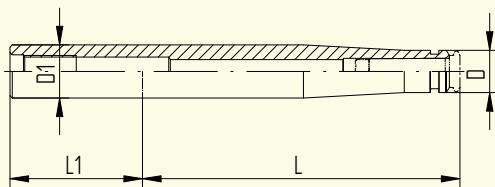

Drawing 1

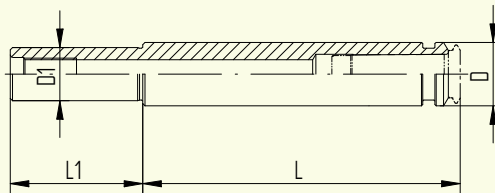

Drawing 2

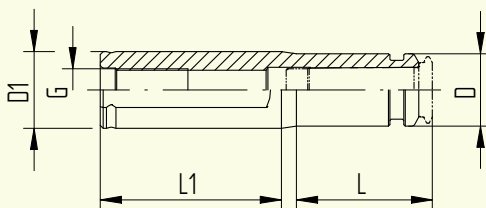

Drawing 3



# CYL toolholders

## CYL-T toolholders

CYL

CYL-T

Type	Part no.	Dimensions [mm]				G	Drawing
		D	L	L1	D1 h6		
<b>CYL 10</b>							
CYL 10 / PG 6 x 120	2610.70620	10	120	30	10	M 5	2
CYL 10 / PG 10 x 120	2610.71020	16	120	40	10	M 5	2
<b>CYL 20</b>							
CYL 20 / PG 10 x 120	2620.71020	16	120	-	20	M 12 x 1	2
CYL 20 / PG 10 x 160	2620.71040	16	160	-	20	M 12 x 1	1
CYL 20 / PG 10 x 200	2620.71060	16	200	-	20	M 12 x 1	1
CYL 20 / PG 15 x 120	2620.71520	24	120	50	20	M 12 x 1	2
<b>CYL 25</b>							
CYL 25 / PG 25 x 80	8020.25080	40	80	50	25	M 12 x 1	2
CYL 25 / PG 25 x 100	8020.25100	40	100	50	25	M 12 x 1	2
CYL 25 / PG 25 x 120	8020.25120	40	120	50	25	M 12 x 1	2

Type	Part no.	Dimensions [mm]				G	Drawing
		D	L	L1	D1 h6		
<b>CYL-T 25 [mm]</b>							
CYL-T 25 / PG 15 x 045	2625.71522	24	45	60	25	M 14 x 1	3
<b>CYL-T 1 [inch]</b>							
CYL-T 1" / PG 15 x 045	2625.71523	24	45	60	25.4	M 14 x 1	3
<b>CYL-T 1 1/4 [inch]</b>							
CYL-T 1 1/4" / PG 15 x 045	2631.71523	24	45	60	31.75	M 14 x 1	3
CYL-T 1 1/4" / PG 25 x 070	2631.72543	40	70	60	31.75	M 22 x 1.5	4
<b>CYL-T 32 [mm]</b>							
CYL-T 32 / PG 15 x 045	2632.71522	24	45	60	32	M 14 x 1	4
CYL-T 32 / PG 25 x 070	2632.72542	40	70	60	32	M 22 x 1.5	4
<b>CYL-T 1 1/2 [inch]</b>							
CYL-T 1 1/2" / PG 15 x 050	2638.71523	24	50	60	38.1	M 14 x 1	3
CYL-T 1 1/2" / PG 25 x 065	2638.72543	40	65	60	38.1	M 22 x 1.5	4
<b>CYL-T 40</b>							
CYL-T 40 / PG 15 x 050	2640.71522	24	50	60	40	M 14 x 1	3
CYL-T 40 / PG 25 x 065	2640.72542	40	65	60	40	M 22 x 1.5	5

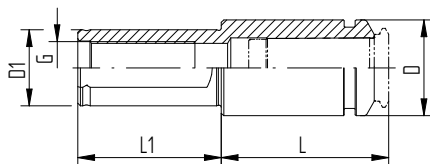

Drawing 4

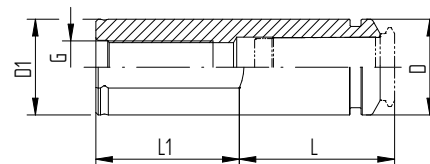

Drawing 5

# ISO 20 toolholder



**Applications** The REGO-FIX ISO 20 toolholders are designed to work with the HAAS Office Mill. To utilize the full potential of your machine, use the REGO-FIX brand of holders and collets to see the difference quality can achieve in your machining operations.

**Balancing** 100 % balanced to G 2.5 @ 40,000 rpm.

**Matched tooling system for best fit** For highest precision and best results the whole system counts. Therefore REGO-FIX components are carefully matched for optimum fit and accuracy. This guarantees the best runout and balance.

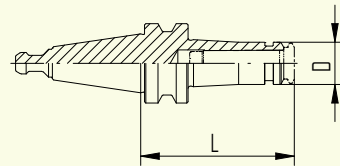

ISO/PG

Type	Part no.	Dimensions [mm]	
		D	L
<b>ISO</b>			
ISO 20 / PG 10 x 058 HAAS	2420.71015	16	58



# Form-fit for 100% pullout protection



**Form and force-fitting clamping system** Tools and collets are 100% secured against tool pull-out, making secuRgrip your safety net for successful machining. In high performance cutting (HPC), the tool can pull out of the clamping system during the milling operation and damage the workpiece. We developed the secuRgrip locking system for operators who want to avoid any pull-out.

**Process security** Optimize your machining productivity by securing your processes.

Our secuRgrip solution fits all standard tools with endmill flat according to DIN 6535-HB (metric). This means, that no special tool shank form is required.

**secuRgrip® system elements**

- // secuRgrip threaded insert  
For all shanks with Weldon surface
- // secuRgrip toolholder with thread
- // secuRgrip PG 25-SG or PG 32-SG collet
- // secuRgrip safety nut

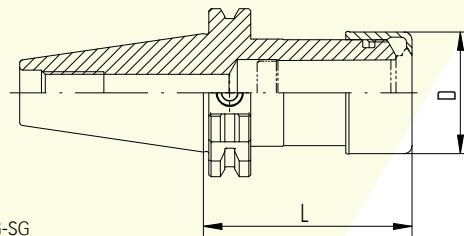

PG-SG

Expert advice

Freewheel wrench head, grip bar or torque wrench are required to safely fasten nut.



Type	Part no.	Form B Part no.	Dimensions [mm]		Accessory
			D [mm]	L [inch]	FWR ...*
<b>CAT / PG-SG</b>					
CAT 40 / PG 25-SG x 2.8"	5340.72531	–	46	2.8"	–
CAT 40 / PG 25-SG x 3.15" H	5340.72541	5340.72544	46	3.15"	405
CAT 40 / PG 25-SG x 4" H	5340.72551	5340.72554	46	4"	405
CAT 40 / PG 25-SG x 6" H	5340.72571	5340.72574	46	6"	405/405
CAT 40 / PG 32-SG x 3.5"	5340.73201	–	55	3.5"	–
CAT 40 / PG 32-SG x 4.3" H	5340.73251	5340.73254	55	4.3"	505
CAT 40 / PG 32-SG x 6" H	5340.73271	5340.73274	55	6"	505/505
CAT 50 / PG 25-SG x 4" H	5350.72551	5350.72554	46	4"	405
CAT 50 / PG 25-SG x 6" H	5350.72571	5350.72574	46	6"	405/405
•CAT 50 / PG 25 HD-SG x 6" H	5350.82571	–	46	6"	405
CAT 50 / PG 32-SG x 3.1" H	5350.73231	–	55	3.1"	505
CAT 50 / PG 32-SG x 4.3" H	5350.73251	5350.73254	55	4.3"	505
•CAT 50 / PG 32 HD-SG x 4.3" H	5350.83251	–	55	4.3"	505
CAT 50 / PG 32-SG x 6" H	5350.73271	5350.73274	55	6"	505/505
•CAT 50 / PG 32 HD-SG x 6" H	5350.83271	–	55	6"	505
<b>CAT+ / PG-SG</b>					
CAT+ 40 / PG 25-SG x 3.15" H	5340.72546	–	46	3.15"	405
CAT+ 40 / PG 25-SG x 6" H	5340.72576	–	46	6"	405/405
CAT+ 40 / PG 32-SG x 3.5"	5340.73206	–	55	3.5"	–
CAT+ 40 / PG 32-SG x 4.3" H	5340.73256	–	55	4.3"	505
CAT+ 40 / PG 32-SG x 6" H	5340.73276	–	55	6"	505/505
CAT+ 50 / PG 25-SG x 4" H	5350.72556	–	46	4"	405
CAT+ 50 / PG 25-SG x 6" H	5350.72576	–	46	6"	405/405
CAT+ 50 / PG 32-SG x 4.3" H	5350.73256	–	55	4.3"	505
CAT+ 50 / PG 32-SG x 6" H	5350.73276	–	55	6"	505/505
<b>SK / PG-SG</b>					
SK 40 / PG 25-SG x 080 H	5240.72540	–	46	80	405
SK 40 / PG 25-SG x 120 H	5240.72560	–	46	120	405
SK 40 / PG 25-SG x 160 H	5240.72580	–	46	160	405 / 405
SK 40 / PG 32-SG x 080	5240.73240	–	55	80	–
SK 50 / PG 32-SG x 080	5250.73240	–	55	80	–

\* Balancing rings H: Ready to accept balancing rings

Included in delivery: secuRgrip® toolholder with secuRgrip® safety nut.

• Heavy Duty secuRgrip holders up to two times more rigid than standard holders.

Additional lengths and interfaces available on request.

Type	Part no.	Form B Part No.	Dimensions [mm]		Accessory
			D	L	FWR ...*
<b>BT / PG-SG</b>					
BT 40 / PG 25-SG x 080 H	5140.72540	5140.72543	46	80	405
BT 40 / PG 25-SG x 120 H	5140.72560	5140.72563	46	120	405
BT 40 / PG 25-SG x 160 H	5140.72560	5140.72563	46	160	405 / 405
BT 40 / PG 32-SG x 086	5140.73240	5140.73246	55	86	–
BT 50 / PG 25-SG x 100	5150.72550	5140.72553	46	100	–
BT 50 / PG 25-SG x 120 H	5150.72560	–	46	120	405
BT 50 / PG 25-SG x 160 H	5150.72560	–	46	160	405 / 405
BT 50 / PG 25-SG x 200 H	5150.72560	–	46	200	405 / 405
BT 50 / PG 32-SG x 100	5150.73250	5150.73253	55	100	–
<b>BT+ / PG-SG</b>					
BT+ 40 / PG 25-SG x 080 H	5140.72546	–	46	80	505
BT+ 40 / PG 25-SG x 120 H	5140.72566	–	46	120	505
BT+ 40 / PG 25-SG x 160 H	5140.72586	–	46	160	505
BT+ 50 / PG 25-SG x 120 H	5150.72566	–	46	120	505
BT+ 50 / PG 25-SG x 160 H	5150.72586	–	46	160	505
<b>HSK-A / PG-SG</b>					
HSK-A 63 / PG 25-SG x 100 H	5563.72550	–	46	100	405
•HSK-A 63 / PG 25 HD-SG x 100 H	5563.82550	–	46	100	405
HSK-A 63 / PG 25-SG x 120 H	5563.72560	–	46	120	405
HSK-A 63 / PG 25-SG x 160 H	5563.72580	–	46	160	405 / 405
HSK-A 63 / PG 25-SG x 200 H	5563.72590	–	46	200	405 / 405
HSK-A 63 / PG 32-SG x 100	5563.73250	–	55	100	–
HSK-A 63 / PG 32-SG x 120 H	5563.73260	–	55	120	505
HSK-A 80 / PG 25-SG x 100 H	5580.72580	–	46	100	405
HSK-A 80 / PG 32-SG x 105 H	5580.73250	–	55	105	505
HSK-A 100 / PG 25-SG x 100 H	5500.72550	–	46	100	505
•HSK-A 100 / PG 25 HD-SG x 100 H	5500.82550	–	46	100	405
HSK-A 100 / PG 25-SG x 160 H	5500.72580	–	46	160	505 / 405
HSK-A 100 / PG 25-SG x 200 H	5500.72590	–	46	200	505 / 405
HSK-A 100 / PG 32-SG x 106 H	5500.73250	–	55	106	505
•HSK-A 100 / PG 32 HD-SG x 106 H	5500.83250	–	55	106	505
HSK-A 100 / PG 32-SG x 160 H	5500.73280	–	55	160	505
HSK-A 100 / PG 32-SG x 200 H	5500.73290	–	55	200	505 / 505

\* Balancing rings H: Ready to accept balancing rings

Included in delivery: secuRgrip® toolholder with secuRgrip® safety nut.

• Heavy Duty secuRgrip holders up to two times more rigid than standard holders.

Additional lengths and interfaces available on request.

Type	Part no.	Dimensions [mm]		Accessory
		D	L	FWR ...*
•HSK-A 125 / PG 25 HD-SG x 105 H	5502.82550	46	55	405
HSK-A 125 / PG 32-SG x 110 H	5502.73250	55	110	505
•HSK-A 125 / PG 32 HD-SG x 112 H	8020.83250	55	112	505
HSK-A 125 / PG 32-SG x 120 H	8020.73255	55	120	505

## HSK-E & HSK-F / PG-SG

HSK-E 63 / PG 25-SG x 100 H	5563.72554	46	100	405
HSK-F 63 / PG 25-SG x 100 H	5563.72555	46	100	405
HSK-F 63 / PG 25-SG x 160 H	5563.72585	46	160	405 / 405
HSK-F 63 / PG 32-SG x 100	5563.73255	55	100	–
HSK-FP 80 / PG 25-SG x 90 H	8020.13205	46	90	405
•HSK-FP 80 / PG 32 HD-SG x 90 H	–	55	90	505
HSK-FP 80 / PG 32-SG x 100 H	8020.13105	55	100	505
HSK-F 80	Call for availability 800-999-7346			

## C / PG-SG

C5 / PG 25-SG x 80	5805.72540	46	80	–
C5 / PG 25-SG x 100 H	5805.72550	46	100	405
C6 / PG 25-SG x 085	5806.72540	46	85	–
C6 / PG 25-SG x 100 H	5806.72550	46	100	405
C6 / PG 25-SG x 120 H	5806.72560	46	120	405
C6 / PG 25-SG x 160 H	5806.72580	46	160	405 / 405
C6 / PG 32-SG x 090	5806.73240	55	90	–
C8 / PG 25-SG x 092	5808.72540	46	92	–
C8 / PG 32-SG x 090	5808.73240	55	90	–

\* Balancing rings H: Ready to accept balancing rings

Included in delivery: secuRgrip® toolholder with secuRgrip® safety nut.

• Heavy Duty secuRgrip holders up to two times more rigid than standard holders. Additional lengths and interfaces available on request.

Type	Part no.	Suitable to
<b>Freewheel wrench heads A-FLS for PG-SG</b>		
A-FLS Ø 28.0 / SG 15	7855.16000	PG-SG 15
A-FLS Ø 46.0 / SG 25	7655.25000	PG-SG 25
A-FLS Ø 55.0 / SG 32	7655.32000	PG-SG 32
G-A SG Wrench Handle*	7655.99900	All the above

\* Torque wrenches available, see page 84

<b>SGN-PG secuRgrip Nuts</b>		
SGN-PG 15 SG Nut	7654.15000	PG-SG 15
SGN-PG 25 SG Nut	7654.25000	PG-SG 25
SGN-PG 32 SG Nut	7654.32000	PG-SG 32

See page 84 for further technical information.

### Expert advice

For all secuRgrip collet & insert part numbers, please refer to page 77.

# All-new Heavy Duty secuRgrip® Toolholders

**HD-SG PG Holders** New Heavy Duty secuRgrip toolholders are up to two times more rigid than standard holders. And, they include secuRgrip design for 100% protection against tool pullout.

## Features

- // Includes secuRgrip design to prevent pullout
- // Most designs retain the use of balance rings
- // Fits existing powRgrip clamping units

## Key Advantages

- // Up to 2 times more rigid than standard holders
- // Increases feed rates to maximize tooling efficiency
- // Better surface finish with less deflection



Type	Part no.	Dimensions [mm]		Accessory
		D	L	FWR ...*
<b>HD-SG Toolholders</b>				
HSK-A 63 / PG 25 HD-SG x 100 H	5563.82550	46	100	405
HSK-FP 80 / PG 32 HD-SG x 90 H	-	55	90	505
HSK-A 100 / PG 25 HD-SG x 100 H	5500.82550	46	100	405
HSK-A 100 / PG 32 HD-SG x 106 H	5500.83250	55	106	505
HSK-A 125 / PG 25 HD-SG x 105 H	5502.82550	46	105	405
HSK-A 125 / PG 32 HD-SG x 112 H	5502.83250	55	112	505
CAT 50 / PG 25 HD-SG x 6" H	5350.82571	46	6"	405
CAT 50 / PG 32 HD-SG x 4.3" H	5350.83251	55	4.3"	505
CAT 50 / PG 32 HD-SG x 6" H	5350.83271	55	6"	505

Included in delivery: secuRgrip® toolholder with secuRgrip® safety nut.

\* Balancing rings H: Ready to accept balancing rings



# PG thread-cutting solutions

## CYL SSY / HSK-A SSY Softsynchro® tapping holder

- // With minimum length compensation
- // Eliminates small synchronization errors of machines

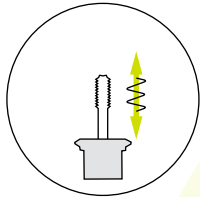

### Applications

- // Machines for direct thread cutting
- // For all tapping tools with h9 shanks
- // The turning movement of the spindles can be offset with the feed axis and thus synchronized
- // Synchronization errors are created by the dynamics of the spindle and linear drives. The tapping holder is equipped with the minimum length compensation and compensates the synchronization errors
- // Depending on the application, the service life for the customer can be increased by up to 150 %
- // Guides coolant with up to 50 bar / 725 PSI of pressure to the tap, without compromising length compensation

## CYL GSF tapping holder

- // With length compensation
- // Used on machines in which the feed movement is not synchronized with the thread pitch during processing

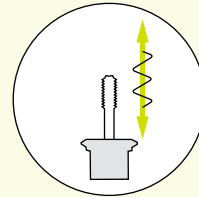

### Applications

- // For machines without a tapping option
- // Ensures the compensation of differences between the thread pitch and spindle feed
- // Features a pressure-point mechanism
- // Safe tap cutting
- // Uniform, reproducible thread depths
- // Guides coolant with up to 50 bar / 725 PSI of pressure to the tap, without compromising length compensation
- // Universal use thanks to its compact design and low gauge length

### Comparative axial force testing

Occurring axial forces with thread forms M10 in St37. Speed 500 rpm.  
Source: In-house testing

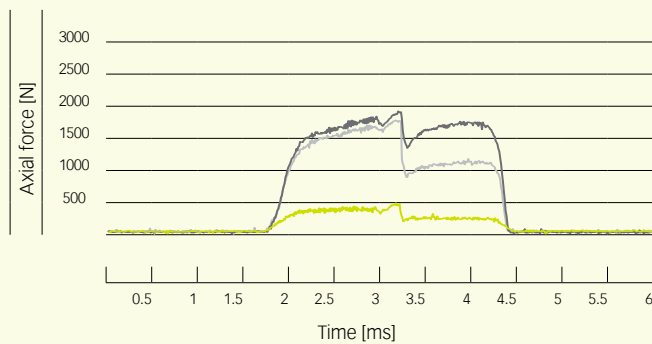

### Comparative axial force testing

Occurring axial forces with thread forms M10 in St37. Speed 2,000 rpm.  
Source: In-house testing

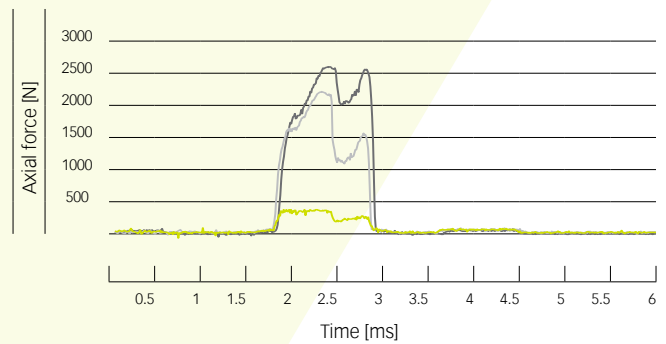

- REGO-FIX Softsynchro® tapping holders
- Competitor synchronous toolholder
- Rigid synchronous toolholder

**Summary** The axial forces increase with increasing speed. With a rigid toolholder, the forces occurring when forming threads are considerably higher than with the Softsynchro® tapping holder. This allows for the optimum use of the synchronous spindle with the best possible service life and thread surface quality.

# PG tapping holders

**HSK-A SSY**

DIN 1835

ISO 12164

**CYL SSY**

DIN 1835

**CYL GSF**

DIN 1835 B

DIN 1835

Type	Part no.	Dimensions [mm]		Compression	Tension
		D	L	[mm]	[mm]
<b>HSK-A SSY</b>					
HSK-A 63 SSY / PG 15	2563.61507	24	114.5	0.5	0.5
HSK-A 63 SSY / PG 25	2563.62507	40	131	0.5	0.5

For tapping collets, please refer to page 76.







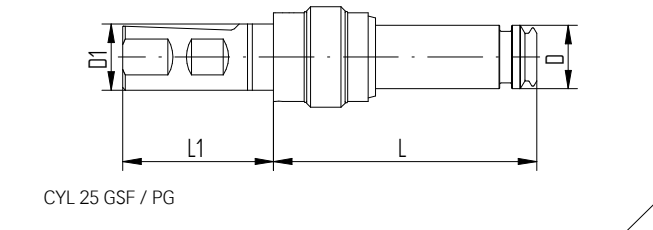
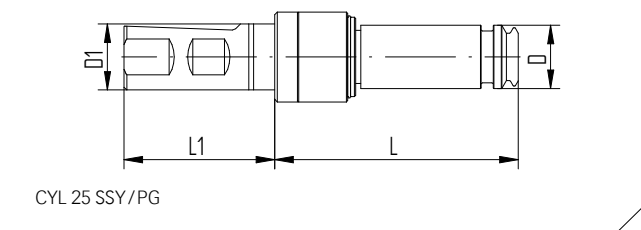
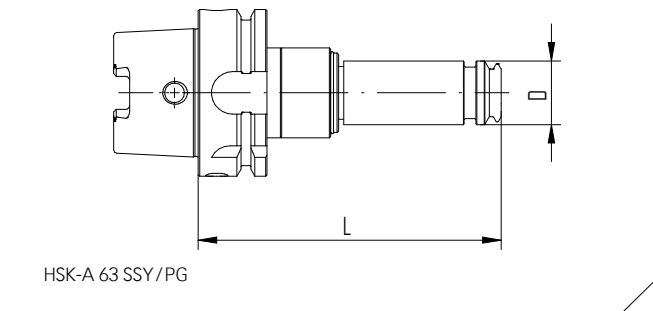

Type	Part no.	Dimensions [mm]				Compression	Tension
		D	D1	L	L1	[mm]	[mm]
<b>CYL SSY</b>							
CYL 25 SSY / PG 15	2625.61507	24	25	92	57	0.5	0.5
CYL 25 SSY / PG 25	2625.62507	40	25	109.5	57	0.5	0.5

For tapping collets, please refer to page 76.

Type	Part no.	Dimensions [mm]				Compression	Tension
		D	D1	L	L1	[mm]	[mm]
<b>CYL GSF</b>							
CYL 25 GSF / PG 15	2625.61508	24	25	99.5	57	5	7.5
CYL 25 GSF / PG 25	2625.62508	40	25	134	57	7	10

For tapping collets, please refer to page 76.



Micro machining	Standard	Cooling	Long shanks	Short shanks	Turning collets	Pullout protection secuRgrip®	Collets for tapping
PG-MB	PG	PG-CF	PG-L	PG-S	PG-T	PG-SG	PG-TAP
							
page 66	page 67	page 70	page 73	page 74	page 76	page 77	page 78





# The most powerful collets yet

Our holistic system approach ensures powerful clamping with a total system runout – holder and collet combined – of less than three microns.

**Experience the quality of the triangle** The outstanding design paired with our experienced engineering make the PG products our most powerful tool-clamping options. What you see is what you get: all our PG products bear the REGO-FIX triangle – our seal for outstanding quality and true Swissness.

## Key advantages

### Rely on the powerful

#### Total system runout TIR $\leq 0.0001$ » (3 $\mu\text{m}$ )

Our holistic system consists of a powRgrip® toolholder and collet. All components together ensure best runout and accuracy.

#### Accurate length adjustment repeatability $< 0.0004$ » (10 $\mu\text{m}$ )

Thanks to the integrated adjustment screw.

#### Clamping of all h6 tool shanks

Cylindrical, WELDON, Whistle-Notch.

#### Clamping of all shank materials

Solid carbide and HSS tool shanks.

#### Clamping diameters

0.2 to 25.4 mm.



#### Swiss quality standard

Our products marked Swiss made are manufactured at our headquarters in Tenniken, Switzerland.

# Swiss quality collets for your production

Our wide product range offers the perfect collet for every application.

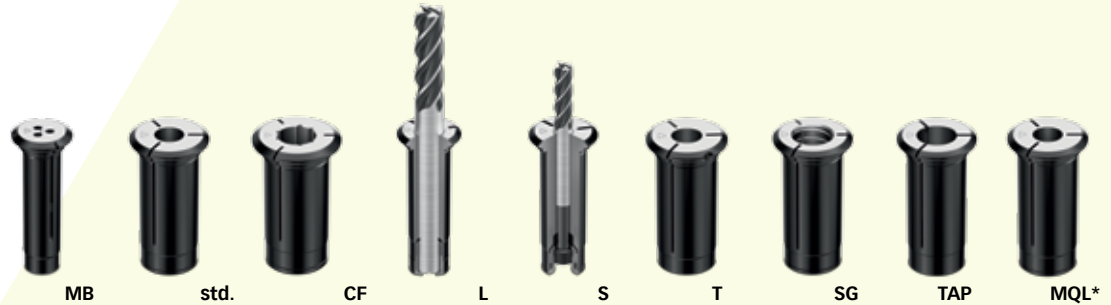

	MB	std.	CF	L	S	T	SG	TAP	MQL*
	microbore	standard	coolant flush	long	short	turning applications	secuRgrip®	tapping collet	minimum quantity lubrication
Main machining use	micro-machining	general machining	peripheral cooling	longer than DIN 6535	shorter than DIN 6535	turning	heavy machining	rigid tapping	milling
PG size	6–10	6–32	6–32	15–32	6–32	15–25	15–32	15–25	15–32
Shaft diameter range (mm)	0.2–1.579	2–25.4	2–25.4	4–25.4	3–25.4	5–20	10–25.4	3.5–16	5–25.4
Clamping range (mm) or tolerance	h6	h6	h6	h6	h6	h9	h6	h9	h6
Runout TIR	Collet runout ≤2 µm / total system runout ≤3 µm								
For tools with internal coolant supply	–	•	–	•	•	•	•	•	•
Metallic sealed	–	•	–	•	•	•	•	–	•
Internal square	–	–	–	–	–	–	–	•	–
secuRgrip® thread to prevent tool pullout	–	–	–	–	–	–	•	–	–
Technical illustration of cooling	–								
Additional features	–	Length can be pre-adjusted with VEW	Length can be pre-adjusted with VEW	Without stop screw	Length can be pre-adjusted with VEW	–	For all tools with endmill flat as per DIN 535-HB	Length can be pre-adjusted with VEW	–
More information on	page 66	page 67	page 70	page 73	page 74	page 76	page 77	page 78	–

\*MQL-compatible collets available on request.

All our products are manufactured to meet our high demands in engineering and design. We say Swiss made and we mean it. Products marked Swiss made are manufactured at our headquarters in Tenniken, Switzerland.

Outstanding Swiss quality



Type	Part no.	Ø		
		[mm]	[decimal inch]	[inch]
<b>PG 6-MB [mm]</b>				
Ø 0.2 mm	1706.00209	0.2	0.0079	–
Ø 0.3 mm	1706.00309	0.3	0.0118	–
Ø 0.4 mm	1706.00409	0.4	0.0157	–
Ø 0.5 mm	1706.00509	0.5	0.0197	–
Ø 0.6 mm	1706.00609	0.6	0.0236	–
Ø 0.7 mm	1706.00709	0.7	0.0276	–
Ø 0.8 mm	1706.00809	0.8	0.0315	–
Ø 0.9 mm	1706.00909	0.9	0.0354	–
Ø 1.0 mm	1706.01009	1.0	0.0394	–
Ø 1.5 mm	1706.01509	1.5	0.0591	–

<b>PG 6-MB [inch]</b>				
Ø 1/16"	1706.01599	1.5875	0.0625	1/16"

<b>PG 10-MB [mm]</b>				
Ø 0.2 mm	1710.00209	0.2	0.0079	–
Ø 0.3 mm	1710.00309	0.3	0.0118	–
Ø 0.4 mm	1710.00409	0.4	0.0157	–
Ø 0.5 mm	1710.00509	0.5	0.0197	–
Ø 0.6 mm	1710.00609	0.6	0.0236	–
Ø 0.7 mm	1710.00709	0.7	0.0276	–
Ø 0.8 mm	1710.00809	0.8	0.0315	–
Ø 0.9 mm	1710.00909	0.9	0.0354	–
Ø 1.0 mm	1710.01009	1.0	0.0394	–
Ø 1.5 mm	1710.01509	1.5	0.0591	–

<b>PG 10-MB [inch]</b>				
Ø 1/16"	1710.01589	1.5875	0.0625	1/16"



Type	Part no.	Ø		
		[mm]	[decimal inch]	[inch]
<b>PG 6 [mm]</b>				
Ø 2.0 mm	1706.02000	2.0	0.0787	–
Ø 2.5 mm	1706.02500	2.5	0.0984	–
Ø 3.0 mm	1706.03000	3.0	0.1181	–
<b>PG 6 [inch]</b>				
Ø 1/8"	1706.03181	3.175	0.125	1/8"
<b>PG 10 [mm]</b>				
Ø 2.0 mm	1710.02000	2.0	0.0787	–
Ø 2.5 mm	1710.02500	2.5	0.0984	–
Ø 3.0 mm	1710.03000	3.0	0.1181	–
Ø 3.5 mm	1710.03500	3.5	0.1378	–
Ø 4.0 mm	1710.04000	4.0	0.1575	–
Ø 4.5 mm	1710.04500	4.5	0.1772	–
Ø 5.0 mm	1710.05000	5.0	0.1969	–
Ø 5.5 mm	1710.05500	5.5	0.2165	–
Ø 6.0 mm	1710.06000	6.0	0.2362	–
<b>PG 10 [inch]</b>				
Ø 1/8"	1710.03181	3.175	0.125	1/8"
Ø 3/16"	1710.04761	4.763	0.1875	3/16"
Ø 1/4"	1710.06351	6.35	0.25	1/4"
<b>PG 15 [mm]</b>				
Ø 3.0 mm	1715.03000	3.0	0.1181	–
Ø 3.5 mm	1715.03500	3.5	0.1378	–
Ø 4.0 mm	1715.04000	4.0	0.1575	–
Ø 4.5 mm	1715.04500	4.5	0.1772	–
Ø 5.0 mm	1715.05000	5.0	0.1969	–
Ø 5.5 mm	1715.05500	5.5	0.2165	–
Ø 6.0 mm	1715.06000	6.0	0.2362	–
Ø 7.0 mm	1715.07000	7.0	0.2756	–
Ø 8.0 mm	1715.08000	8.0	0.315	–
Ø 9.0 mm	1715.09000	9.0	0.3543	–
Ø 10.0 mm	1715.10000	10.0	0.3937	–

Type	Part no.	Ø		
		[mm]	[decimal inch]	[inch]
<b>PG 15 [inch]</b>				
Ø 1/8"	1715.03181	3.175	0.125	1/8"
Ø 3/16"	1715.04761	4.763	0.1875	3/16"
Ø 1/4"	1715.06351	6.35	0.25	1/4"
Ø 5/16"	1715.07941	7.938	0.3125	5/16"
Ø 3/8"	1715.09521	9.525	0.375	3/8"

<b>PG 25 [mm]</b>				
Ø 3.0 mm	1725.03000	3.0	0.1181	–
Ø 3.5 mm	1725.03500	3.5	0.1378	–
Ø 4.0 mm	1725.04000	4.0	0.1575	–
Ø 4.5 mm	1725.04500	4.5	0.1772	–
Ø 5.0 mm	1725.05000	5.0	0.1969	–
Ø 5.5 mm	1725.05500	5.5	0.2165	–
Ø 6.0 mm	1725.06000	6.0	0.2362	–
Ø 7.0 mm	1725.07000	7.0	0.2756	–
Ø 8.0 mm	1725.08000	8.0	0.315	–
Ø 9.0 mm	1725.09000	9.0	0.3543	–
Ø 10.0 mm	1725.10000	10.0	0.3937	–
Ø 11.0 mm	1725.11000	11.0	0.4331	–
Ø 12.0 mm	1725.12000	12.0	0.4724	–
Ø 13.0 mm	1725.13000	13.0	0.5118	–
Ø 14.0 mm	1725.14000	14.0	0.5512	–
Ø 15.0 mm	1725.15000	15.0	0.5906	–
Ø 16.0 mm	1725.16000	16.0	0.63	–
Ø 18.0 mm	1725.18000	18.0	0.7087	–
Ø 20.0 mm	1725.20000	20.0	0.7874	–

<b>PG 25 [inch]</b>				
Ø 1/8"	1725.03181	3.175	0.125	1/8"
Ø 3/16"	1725.04761	4.763	0.1875	3/16"
Ø 1/4"	1725.06351	6.35	0.25	1/4"
Ø 5/16"	1725.07941	7.938	0.3125	5/16"
Ø 3/8"	1725.09521	9.525	0.375	3/8"
Ø 7/16"	1725.11111	11.113	0.4375	7/16"
Ø 1/2"	1725.12701	12.7	0.5	1/2"
Ø 9/16"	1725.14291	14.288	0.5625	9/16"
Ø 5/8"	1725.15881	15.875	0.625	5/8"
Ø 11/16"	1725.17461	17.463	0.6875	11/16"
Ø 3/4"	1725.19051	19.05	0.75	3/4"

Type	Part no.	Ø		
		[mm]	[decimal inch]	[inch]
<b>PG 32 [mm]</b>				
Ø 6.0 mm	1732.06000	6.0	0.2362	–
Ø 7.0 mm	1732.07000	7.0	0.2756	–
Ø 8.0 mm	1732.08000	8.0	0.315	–
Ø 9.0 mm	1732.09000	9.0	0.3543	–
Ø 10.0 mm	1732.10000	10.0	0.3937	–
Ø 11.0 mm	1732.11000	11.0	0.4331	–
Ø 12.0 mm	1732.12000	12.0	0.4724	–
Ø 14.0 mm	1732.14000	14.0	0.5512	–
Ø 16.0 mm	1732.16000	16.0	0.63	–
Ø 18.0 mm	1732.18000	18.0	0.7087	–
Ø 20.0 mm	1732.20000	20.0	0.7874	–
Ø 22.0 mm	1732.22000	22.0	0.8661	–
Ø 25.0 mm	1732.25000	25.0	0.9843	–

<b>PG 32 [inch]</b>				
Ø 1/4"	1732.06351	6.35	0.25	1/4"
Ø 5/16"	1732.07941	7.938	0.3125	5/16"
Ø 3/8"	1732.09521	9.525	0.375	3/8"
Ø 7/16"	1732.11111	11.113	0.4375	7/16"
Ø 1/2"	1732.12701	12.7	0.5	1/2"
Ø 9/16"	1732.14291	14.288	0.5625	9/16"
Ø 5/8"	1732.15881	15.875	0.625	5/8"
Ø 3/4"	1732.19051	19.05	0.75	3/4"
Ø 7/8"	1732.22231	22.225	0.875	7/8"
Ø 1"	1732.25401	25.4	1.0	1"



Type	Part no.	Ø		
		[mm]	[decimal inch]	[inch]
<b>PG 6-CF [mm]</b>				
Ø 2.0 mm	1706.02002	2.0	0.0787	–
Ø 3.0 mm	1706.03002	3.0	0.1181	–
<b>PG 10-CF [mm]</b>				
Ø 2.0 mm	1710.02002	2.0	0.0787	–
Ø 3.0 mm	1710.03002	3.0	0.1181	–
Ø 4.0 mm	1710.04002	4.0	0.1575	–
Ø 5.0 mm	1710.05002	5.0	0.1969	–
Ø 6.0 mm	1710.06002	6.0	0.2362	–
<b>PG 10-CF [inch]</b>				
Ø 1/8"	1710.03183	3.175	0.125	1/8"
Ø 3/16"	1710.04763	4.763	0.1875	3/16"
Ø 1/4"	1710.06353	6.35	0.25	1/4"
<b>PG 15-CF [mm]</b>				
Ø 3.0 mm	1715.03002	3.0	0.1181	–
Ø 4.0 mm	1715.04002	4.0	0.1575	–
Ø 5.0 mm	1715.05002	5.0	0.1969	–
Ø 6.0 mm	1715.06002	6.0	0.2362	–
Ø 7.0 mm	1715.07002	7.0	0.2756	–
Ø 8.0 mm	1715.08002	8.0	0.315	–
Ø 9.0 mm	1715.09002	9.0	0.3543	–
Ø 10.0 mm	1715.10002	10.0	0.3937	–
<b>PG 15-CF [inch]</b>				
Ø 1/8"	1715.03183	3.175	0.125	1/8"
Ø 3/16"	1715.04763	4.763	0.1875	3/16"
Ø 1/4"	1715.06353	6.35	0.25	1/4"
Ø 5/16"	1715.07943	7.938	0.3125	5/16"
Ø 3/8"	1715.09523	9.525	0.375	3/8"



Type	Part no.	Ø		
		[mm]	[decimal inch]	[inch]
<b>PG 25-CF [mm]</b>				
Ø 3.0 mm	1725.03002	3.0	0.1181	–
Ø 4.0 mm	1725.04002	4.0	0.1575	–
Ø 5.0 mm	1725.05002	5.0	0.1969	–
Ø 6.0 mm	1725.06002	6.0	0.2362	–
Ø 7.0 mm	1725.07002	7.0	0.2756	–
Ø 8.0 mm	1725.08002	8.0	0.315	–
Ø 9.0 mm	1725.09002	9.0	0.3543	–
Ø 10.0 mm	1725.10002	10.0	0.3937	–
Ø 11.0 mm	1725.11002	11.0	0.4331	–
Ø 12.0 mm	1725.12002	12.0	0.4724	–
Ø 13.0 mm	1725.13002	13.0	0.5118	–
Ø 14.0 mm	1725.14002	14.0	0.5512	–
Ø 15.0 mm	1725.15002	15.0	0.5906	–
Ø 16.0 mm	1725.16002	16.0	0.63	–
Ø 18.0 mm	1725.18002	18.0	0.7087	–
Ø 20.0 mm	1725.20002	20.0	0.7874	–

<b>PG 25-CF [inch]</b>				
Ø 1/8"	1725.03183	3.175	0.125	1/8"
Ø 3/16"	1725.04763	4.763	0.1875	3/16"
Ø 1/4"	1725.06353	6.35	0.25	1/4"
Ø 5/16"	1725.07943	7.938	0.3125	5/16"
Ø 3/8"	1725.09523	9.525	0.375	3/8"
Ø 7/16"	1725.11113	11.113	0.4375	7/16"
Ø 1/2"	1725.12703	12.7	0.5	1/2"
Ø 9/16"	1725.14293	14.288	0.5625	9/16"
Ø 5/8"	1725.15883	15.875	0.625	5/8"
Ø 3/4"	1725.19053	19.05	0.75	3/4"



## PG 32-CF [mm]

Ø 6.0 mm	1732.06002	6.0	0.2362	–
Ø 7.0 mm	1732.07002	7.0	0.2756	–
Ø 8.0 mm	1732.08002	8.0	0.315	–
Ø 9.0 mm	1732.09002	9.0	0.3543	–
Ø 10.0 mm	1732.10002	10.0	0.3937	–
Ø 11.0 mm	1732.11002	11.0	0.4331	–
Ø 12.0 mm	1732.12002	12.0	0.4724	–
Ø 14.0 mm	1732.14002	14.0	0.5512	–
Ø 16.0 mm	1732.16002	16.0	0.63	–
Ø 18.0 mm	1732.18002	18.0	0.7087	–
Ø 20.0 mm	1732.20002	20.0	0.7874	–
Ø 22.0 mm	1732.22002	22.0	0.8661	–
Ø 25.0 mm	1732.25002	25.0	0.9843	–

## PG 32-CF [inch]

Ø 1/4"	1732.06353	6.35	0.25	1/4"
Ø 5/16"	1732.07943	7.938	0.3125	5/16"
Ø 3/8"	1732.09523	9.525	0.375	3/8"
Ø 7/16"	1732.11113	11.113	0.4375	7/16"
Ø 1/2"	1732.12703	12.7	0.5	1/2"
Ø 9/16"	1732.14293	14.288	0.5625	9/16"
Ø 5/8"	1732.15883	15.875	0.625	5/8"
Ø 3/4"	1732.19053	19.05	0.75	3/4"
Ø 7/8"	1732.22233	22.225	0.875	7/8"
Ø 1"	1732.25403	25.4	1.0	1"



Type	Part no.	Ø		
		[mm]	[decimal inch]	[inch]
<b>PG 15-L [mm]</b>				
Ø 4.0 mm	1715.04001	4.0	0.1575	–
Ø 5.0 mm	1715.05001	5.0	0.1969	–
Ø 6.0 mm	1715.06001	6.0	0.2362	–
Ø 8.0 mm	1715.08001	8.0	0.315	–
Ø 10.0 mm	1715.10001	10.0	0.3937	–
<b>PG 15-L [inch]</b>				
Ø 1/4"	1715.06350	6.35	0.25	1/4"
Ø 5/16"	1715.07940	7.94	0.3126	5/16"
Ø 3/8"	1715.09520	9.52	0.3748	3/8"
<b>PG 25-L [mm]</b>				
Ø 6.0 mm	1725.06001	6.0	0.2362	–
Ø 8.0 mm	1725.08001	8.0	0.315	–
Ø 10.0 mm	1725.10001	10.0	0.3937	–
Ø 12.0 mm	1725.12001	12.0	0.4724	–
Ø 14.0 mm	1725.14001	14.0	0.5512	–
Ø 16.0 mm	1725.16001	16.0	0.6299	–
Ø 20.0 mm	1725.20001	20.0	0.7874	–
<b>PG 25-L [inch]</b>				
Ø 1/4"	1725.06350	6.35	0.25	1/4"
Ø 5/16"	1725.07940	7.94	0.3126	5/16"
Ø 3/8"	1725.09520	9.52	0.3748	3/8"
Ø 1/2"	1725.12700	12.7	0.5	1/2"
Ø 5/8"	1725.15880	15.88	0.6252	5/8"
Ø 3/4"	1725.19050	19.05	0.75	3/4"
<b>PG 32-L [mm]</b>				
Ø 12.0 mm	1732.12001	12.0	0.4724	–
Ø 16.0 mm	1732.16001	16.0	0.6299	–
Ø 20.0 mm	1732.20001	20.0	0.7874	–
Ø 25.0 mm	1732.25001	25.0	0.9843	–
<b>PG 32-L [inch]</b>				
Ø 1/2"	1732.12700	12.7	0.5	1/2"
Ø 3/4"	1732.19050	19.05	0.75	3/4"
Ø 1"	1732.25400	25.4	1.0	1"



Type	Part no.	Ø		
		[mm]	[decimal inch]	[inch]
<b>PG 6-S [mm]</b>				
Ø 3.0 mm	1706.03008	3.0	0.1181	–
<b>PG 6-S [inch]</b>				
Ø 1/8"	1706.03188	3.175	0.125	1/8"
<b>PG 10-S [mm]</b>				
Ø 3.0 mm	1710.03008	3.0	0.1181	–
Ø 4.0 mm	1710.04008	4.0	0.1575	–
Ø 6.0 mm	1710.06008	6.0	0.2362	–
<b>PG 10-S [inch]</b>				
Ø 1/8"	1710.03188	3.175	0.125	1/8"
Ø 3/16"	1710.04768	4.763	0.1875	3/16"
Ø 1/4"	1710.06358	6.35	0.25	1/4"
<b>PG 15-S [mm]</b>				
Ø 4.0 mm	1715.04008	4.0	0.1575	–
Ø 5.0 mm	1715.05008	5.0	0.1969	–
Ø 6.0 mm	1715.06008	6.0	0.2362	–
Ø 8.0 mm	1715.08008	8.0	0.315	–
Ø 10.0 mm	1715.10008	10.0	0.3937	–
<b>PG 15-S [inch]</b>				
Ø 1/8"	1715.03188	3.175	0.125	1/8"
Ø 3/16"	1715.04768	4.763	0.1875	3/16"
Ø 1/4"	1715.06358	6.35	0.25	1/4"
Ø 5/16"	1715.07948	7.94	0.3126	5/16"
Ø 3/8"	1715.09528	9.52	0.3748	3/8"
<b>PG 25-S [mm]</b>				
Ø 4.0 mm	1725.04008	4.0	0.1575	–
Ø 6.0 mm	1725.06008	6.0	0.2362	–
Ø 8.0 mm	1725.08008	8.0	0.315	–
Ø 10.0 mm	1725.10008	10.0	0.3937	–
Ø 12.0 mm	1725.12008	12.0	0.4724	–
Ø 14.0 mm	1725.14008	14.0	0.5512	–
Ø 16.0 mm	1725.16008	16.0	0.6299	–
Ø 20.0 mm	1725.20008	20.0	0.7874	–

Type	Part no.	Ø		
		[mm]	[decimal inch]	[inch]
<b>PG 25-S [inch]</b>				
Ø 1/8"	1725.03188	3.175	0.125	1/8"
Ø 3/16"	1725.04768	4.763	0.1875	3/16"
Ø 1/4"	1725.06358	6.358	0.2503	1/4"
Ø 5/16"	1725.07948	7.94	0.3126	5/16"
Ø 3/8"	1725.09528	9.52	0.3748	3/8"
Ø 1/2"	1725.12708	12.7	0.5	1/2"
Ø 5/8"	1725.15888	15.88	0.6252	5/8"
Ø 3/4"	1725.19058	19.05	0.75	3/4"

<b>PG 32-S [mm]</b>				
Ø 12.0 mm	1732.12008	12.0	0.4724	–
Ø 16.0 mm	1732.16008	16.0	0.6299	–
Ø 20.0 mm	1732.20008	20.0	0.7874	–
Ø 25.0 mm	1732.25008	25.0	0.9843	–

<b>PG 32-S [inch]</b>				
Ø 1/2"	1732.12708	12.7	0.5	1/2"
Ø 3/4"	1732.19058	19.05	0.75	3/4"
Ø 1"	1732.25408	25.4	1.0	1"



Type	Part no.	Ø		
		[mm]	[decimal inch]	[inch]
<b>PG 15-T [mm]</b>				
Ø 5.0 mm	1715.05007	5.0	0.1969	–
Ø 6.0 mm	1715.06007	6.0	0.2362	–
Ø 8.0 mm	1715.08007	8.0	0.315	–
Ø 10.0 mm	1715.10007	10.0	0.3937	–

<b>PG 15-T [inch]</b>				
Ø 1/4"	1715.06357	6.35	0.25	1/4"
Ø 3/8"	1715.09537	9.525	0.375	3/8"

<b>PG 25-T [mm]</b>				
Ø 5.0 mm	1725.05007	5.0	0.1969	–
Ø 6.0 mm	1725.06007	6.0	0.2362	–
Ø 8.0 mm	1725.08007	8.0	0.315	–
Ø 10.0 mm	1725.10007	10.0	0.3937	–
Ø 12.0 mm	1725.12007	12.0	0.4724	–
Ø 16.0 mm	1725.16007	16.0	0.6299	–
Ø 20.0 mm	1725.20007	20.0	0.7874	–

<b>PG 25-T [inch]</b>				
Ø 1/4"	1725.06357	6.35	0.25	1/4"
Ø 3/8"	1725.09537	9.525	0.375	3/8"
Ø 1/2"	1725.12707	12.7	0.5	1/2"
Ø 3/4"	1725.19057	19.05	0.75	3/4"



Type	Part no.	Ø		
		[mm]	[decimal inch]	[inch]
<b>PG 15-SG [mm]</b>				
Ø 10.0 mm	1715.10004S	10.0	0.3937	–
<b>PG 25-SG [mm]</b>				
Ø 10.0 mm	1725.10004S	10.0	0.3937	–
Ø 12.0 mm	1725.12004S	12.0	0.4724	–
Ø 14.0 mm	1725.14004S	14.0	0.5512	–
Ø 16.0 mm	1725.16004S	16.0	0.63	–
Ø 18.0 mm	1725.18004S	18.0	0.7087	–
Ø 20.0 mm	1725.20004S	20.0	0.7874	–
<b>PG 25-SG [inch]</b>				
Ø 1/2"	1725.12704S	12.7	0.5	1/2"
Ø 5/8"	1725.15884S	15.875	0.625	5/8"
Ø 3/4"	1725.19054S	19.05	0.75	3/4"
<b>PG 32-SG [mm]</b>				
Ø 10.0 mm	1732.10004S	10.0	0.3937	–
Ø 12.0 mm	1732.12004S	12.0	0.4724	–
Ø 14.0 mm	1732.14004S	14.0	0.5512	–
Ø 16.0 mm	1732.16004S	16.0	0.63	–
Ø 18.0 mm	1732.18004S	18.0	0.7087	–
Ø 20.0 mm	1732.20004S	20.0	0.7874	–
Ø 25.0 mm	1732.25004S	25.0	0.9843	–
<b>PG 32-SG [inch]</b>				
Ø 1/2"	1732.12704S	12.7	0.5	1/2"
Ø 5/8"	1732.15884S	15.875	0.625	5/8"
Ø 3/4"	1732.19054S	19.05	0.75	3/4"
Ø 1"	1732.25404S	25.4	1.0	1"
<b>Threaded insert SGI [mm]</b>				
Ø 10.0 mm	7694.10000			
Ø 12.0 mm	7694.12000			
Ø 14.0 mm	7694.14000			
Ø 16.0 mm	7694.16000			
Ø 18.0 mm	7694.18000			
Ø 20.0 mm	7694.20000			
Ø 25.0 mm	7694.25000			
<b>Threaded insert SGI [inch]</b>				
Ø 1/2"	7694.12700			
Ø 5/8"	7694.15880			
Ø 3/4"	7694.19050			
Ø 1"	7694.25400			



# PG collets for tapping PG-TAP

Manufactured with a form-fitting internal square, the PG-TAP collets successfully prevent the tap from twisting.

## Key features

### Tapping collets without axial compensation

#### Swiss quality

Made in Switzerland to ISO 9001/ISO 14001.

#### Marking

Type and size are marked on the collets to reduce collet selection errors.

#### Traceability

Lot number marking on all products for traceability through the entire manufacturing process.

#### Coolant through tools

Metallic sealed for coolant through tools.

#### Internal square for tap shanks and length adjustment

Internal square for tight grip, integrated length adjustment screw, accepts h9 tool shanks.

**Directions for use** The PG-TAP tapping collets are compatible with DIN standard taps.

The REGO-FIX powRgrip® tapping collets are manufactured with an internal square. They are intended for use on CNC machines that have synchronized machine spindle speed and feed rate. Machines that have such rigid tapping capabilities require only minimal compensation.

We recommend the use of our SSY Softsynchro® tapping holders. They compensate minimal synchronizing differences of CNC machines.

*Please refer to page 60 for additional information on REGO-FIX tapping holders.*

*For machines without tapping option we recommend the use of our axial compensating GSF tapping holders. Please refer to page 60 for more information. For additional technical information and dimensions of taps, please refer to page 93.*

## Expert advice

Clamp h9-tolerance tool shanks only.  
Never clamp tapping collet without a tool or you will risk to damage the collet.

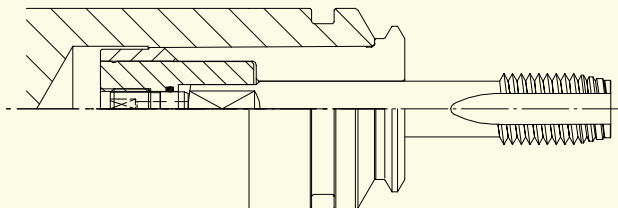

PG-TAP



PG-TAP



# Tapping collet PG-TAP

PG-TAP

DIN 371

DIN 376

Type	Part no.	Ø [mm]	Square [mm]	DIN norm
<b>PG 15-TAP</b>				
Ø 3.5 x 2.7 mm	1715.03505	3.5	2.7	371 / 376
Ø 4.5 x 3.4 mm	1715.04505	4.5	3.4	371 / 376
Ø 6.0 x 4.9 mm	1715.06005	6.0	4.9	371 / 376
Ø 7.0 x 5.5 mm	1715.07005	7.0	5.5	371 / 376
Ø 8.0 x 6.2 mm	1715.08005	8.0	6.2	371 / 376
Ø 9.0 x 7.0 mm	1715.09005	9.0	7.0	371 / 376
Ø 10.0 x 8.0 mm	1715.10005	10.0	8.0	371

<b>PG 25-TAP</b>				
Ø 6.0 x 4.9 mm	1725.06005	6.0	4.9	371 / 376
Ø 8.0 x 6.2 mm	1725.08005	8.0	6.2	371 / 376
Ø 9.0 x 7.0 mm	1725.09005	9.0	7.0	371 / 376
Ø 10.0 x 8.0 mm	1725.10005	10.0	8.0	371
Ø 11.0 x 9.0 mm	1725.11005	11.0	9.0	371 / 376
Ø 12.0 x 9.0 mm	1725.12005	12.0	9.0	371 / 376
Ø 14.0 x 11.0 mm	1725.14005	14.0	11.0	371 / 376
Ø 16.0 x 12.0 mm	1725.16005	16.0	12.0	371 / 376

## Expert advice

Presetting range of PG-TAP collets on pages 90 and 91.  
Table with current dimensions of taps on page 93.



## Contents

# PG accessories

Enhance your tool life with the correct accessories for safe tool clamping.

---

Automatic clamping unit PGU 9500	82
Clamping inserts APG's for PGU 9500	82
Manual clamping unit PGC 2506	83
Clamping inserts APC's for PGC 2506	83
Taper cleaner TKCP	84
Cleaning paper set CPS	84
Hi-Q® balancing rings FWR	84
Torque screwdriver TSD TORX 8	85
Coolant tubes KSR	85
Wrenches SKR	85
Torque wrench TORCO-FIX	86
Freewheel wrench heads A-FLS	86
Grip bar for wrench heads G-A	86
Trays for PG collets CTPG	86
Length-presetting tool VEW	87

---



reddot award 2015  
honourable mention industrial design



# Automatic clamping unit PGU 9500

## Clamping inserts APG's for PGU 9500

PGU 9500

APG

Type	Part no.	Dimensions W x D x H [mm]	Weight [lb]
<b>PGU 9500</b>			
PGU 9500 A	7610.95100	555 x 454 x 648	200

Clamping inserts APG not included.

Type	Part no.	Dimensions W x D x H [mm]	Weight [lb]	Use for
<b>Clamping inserts APG</b>				
APG 906*	7611.06900	100 x 95 x 80	6.6	PG 6
APG 910	7611.10900	100 x 95 x 80	6.6	PG 10
APG 915	7611.15900	100 x 95 x 80	6.6	PG 15
APG 925	7611.25900	100 x 95 x 80	6.6	PG 25
APG 932	7611.32900	100 x 95 x 80	6.6	PG 32

\*APG 906 is only suited for PGU 9006 and 9500. All other APG's can be used for PGU 9000 / 9006 / 9500.

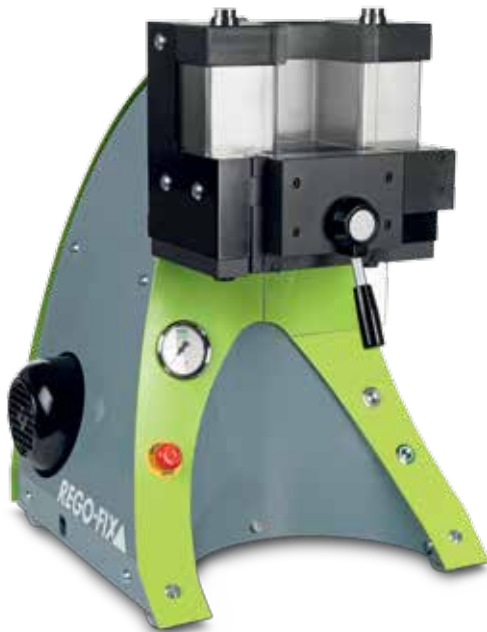

PGU 9500

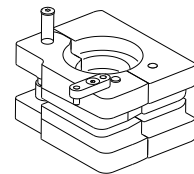

APG

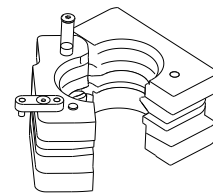

APG (opened)

# Manual clamping unit PGC 2506

## Clamping inserts APC's for PGC 2506

PGC

APC

Type	Part no.	Dimensions W x D x H [mm]	Weight [lb]
<b>PGC</b>			
SET PGC 2506	7621.25069	578 x 420 x 43	40

*Includes clamping unit, hand pump and stand. Does not include APC's.*

Type	Part no.	Dimensions Ø [mm]	Weight [lb]	Use for
<b>Clamping inserts APC</b>				
APC 6	7622.06000	30 x 60	2	PG 6
APC 10	7622.10000	30 x 60	2	PG 10
APC 15	7622.15000	30 x 60	2	PG 15
APC 25	7622.25000	30 x 60	2	PG 25

*\*APC 6 is only suited for SET PGC 2506. All other APC's can be used for SET PGC 2506 and 2510.*



PGC 2506

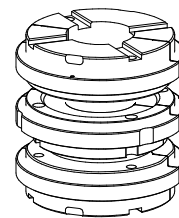

APC

# Taper cleaner TKCP

## Cleaning paper set CPS

### Hi-Q® balancing rings FWR

TKCP

CPS

FWR

Type	Part no.	Use for
<b>Taper cleaner TKCP</b>		
TKCP 6	7657.06000	PG 6
TKCP 10	7657.10000	PG 10
TKCP 15	7657.15000	PG 15
TKCP 25	7657.25000	PG 25
TKCP 32	7657.32000	PG 32

*Includes taper cleaner and cleaning paper set.*

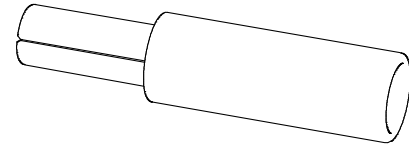

TKCP

Type	Part no.
<b>Cleaning paper set CPS</b>	
CPS 6	7658.06000
CPS 10	7658.10000
CPS 15	7658.15000
CPS 25	7658.25000
CPS 32	7658.32000

*Each CPS contains 250 sheets. For single use only.*

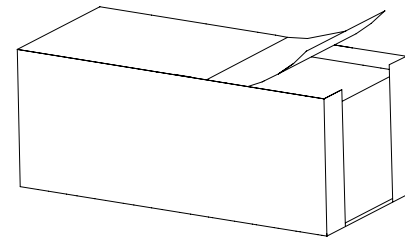

CPS

Type	Part no.	Dimensions [mm]			Balancing capacity [gmm]		
		D	d	L	FWR SET	single FWR	max. rpm
<b>Hi-Q® balancing rings FWR</b>							
SET FWR 225	7490.22500	30.5	22.5	6	16	8	80.000
SET FWR 285	7490.28500	36.5	28.5	6	32	16	70.000
SET FWR 325	7490.32500	40.5	32.5	6	44	22	60.000
SET FWR 405	7490.40500	48.5	40.5	6	52	26	50.000
SET FWR 505	7490.50500	60.5	50.5	7	130	65	42.000

*Included in set: Two Hi-Q® balancing rings per set.*



Balancing rings SET FWR

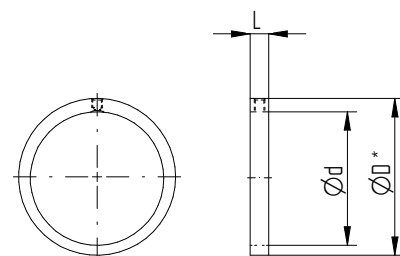

Single balancing ring

\* Rotational diameter

# Torque screwdriver TSD TORX 8

## Coolant tubes KSR

### Key for coolant tubes SKR

TORX T	TSD
KSR	SKR

Type	Part no.
<b>TSD TORX 8 for balancing rings</b>	
TSD 0.9 Nm	7159.09000

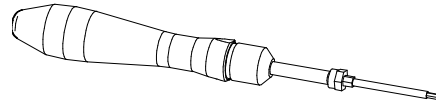

TSD

Type	Part no.	Dimensions [mm]			G
		D	L	L1	
<b>Coolant tubes KSR</b>					
KSR 25	7211.25000	5	4.5	17	M 8 x 1
KSR 32	7211.32000	6	5.5	25.7	M 10 x 1
KSR 40	7211.40000	8	7.5	29.2	M 12 x 1
KSR 50	7211.50000	10	9.5	32.7	M 16 x 1
KSR 63	7211.63000	12	11.5	36.2	M 18 x 1
KSR 80	7211.80000	14	13.5	39.7	M 20 x 1.5
KSR 100	7211.00000	16	15.5	43.6	M 24 x 1.5
KSR 125	7211.12500	16	15.5	43.6	M 24 x 1.5

Type	Part no.
<b>Wrenches SKR</b>	
SKR 25	7212.25000
SKR 32	7212.32000
SKR 40	7212.40000
SKR 50	7212.50000
SKR 63	7212.63000
SKR 80	7212.80000
SKR 100	7212.00000
SKR 125	7212.12500

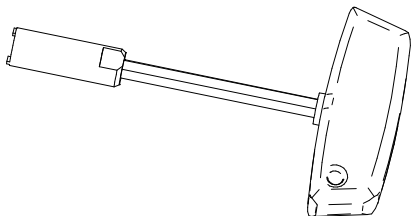

SKR

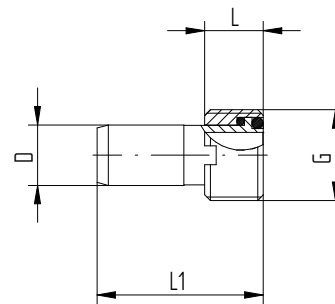

KSR

# Torque wrench TORCO-FIX

## Freewheel wrench heads A-FLS

### Grip bar for wrench heads G-A

### Trays for PG collets CTPG

TORCO-FIX	A-FLS
G-A	CTPG

Type	Part no.	L1 [mm]	Range [ft-lbs]
<b>Torque Wrench</b>			
Medium	8020.20100	340	15-75
Large	8020.60300	545	45-220

Type	Part no.	Suitable to	D [mm]	D1 [mm]
<b>Freewheel wrench heads A-FLS</b>				
A-FLS Ø 28.0 / SG 15	7855.16000	PG 15	28	47
A-FLS Ø 46.0 / SG 25	7655.25000	PG 25	46	68
A-FLS Ø 55.0 / SG 32	7655.32000	PG 32	55	77

<b>Grip bar G-A for wrench heads A-FLS</b>				
G-A	7655.99900	all	-	-

Type	Part no.	Fits...items	Dimensions W x D x H [mm]
<b>Trays for PG collets</b>			
CTPG 6	7698.06000	20	150 x 50 x 30
CTPG 10	7698.10000	14	150 x 50 x 40
CTPG 15	7698.15000	15	150 x 100 x 52
CTPG 25	7698.25000	16	150 x 150 x 60
CTPG 32	7698.32000	9	150 x 150 x 69

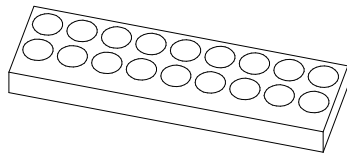

CTPG

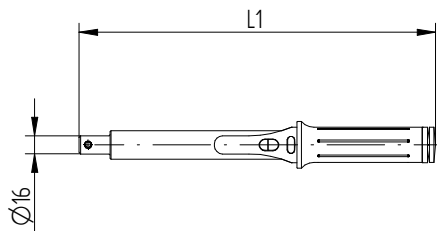

Torque Wrench

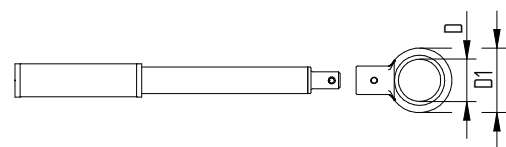

G-A with A-FLS



Type	Part no.
<b>Length-presetting tool VEW</b>	
VEW 6	7619.06000
VEW 10	7619.10000
VEW 15	7619.15000
VEW 25	7619.25000
VEW 32	7619.32000

**Precise tool adjusting** The powRgrip® presetting tool accommodates the powRgrip collet and is inserted into the collet holder. The presetting tool has an adjustment wheel for precise tool adjustments.

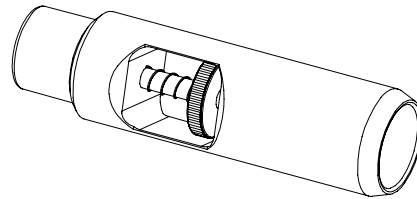

VEW

Length-presetting tool VEW

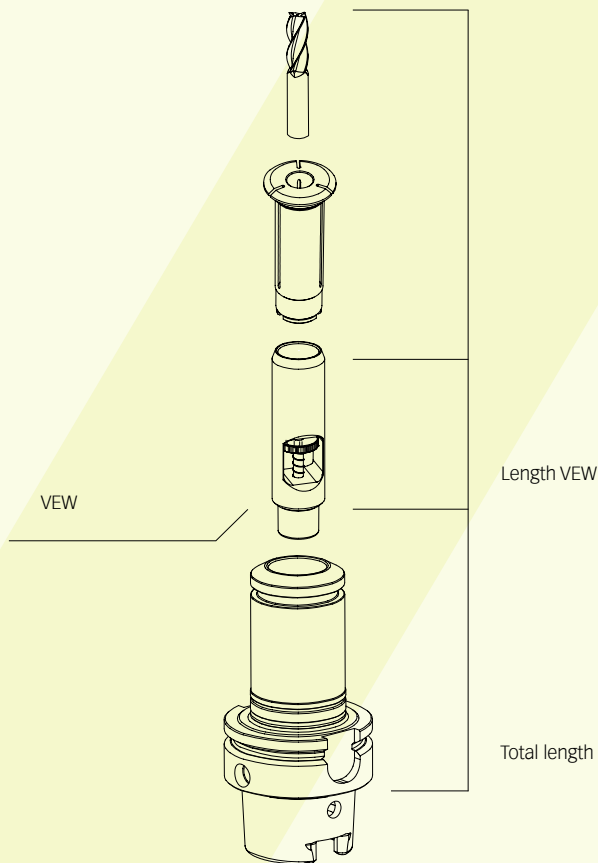

**How it works**

- // Insert the length-presetting tool VEW into the powRgrip toolholder
- // Insert the powRgrip collet into the length presetting tool
- // Insert the cutting tool into the powRgrip collet
- // Adjust the tool length by turning the adjustment wheel
- // Measure the total length of the cutting tool and subtract the length of the VEW (approx. 100 mm) from the total length
- // Remove the presetting tool
- // Clamp collet and cutting tool into the powRgrip toolholder with the powRgrip clamping unit



## Contents

# Technical information

---

Presetting range of powRgrip® collets	90
Spindle interface norms	92
Shank diameter of taps	93
Maximum presetting range for PG standard collets and PG-CF collets	94
Presetting range of PG-TAP collets with internal square	94
Recommended tightening torque for secuRgrip® safety nuts	94
H6 shank tolerances	95

---



# Presetting range of powRgrip® collets

D	D	PG 6/-CF		PG 6-S		PG 10/-CF		PG 10-S		PG 15/-CF		PG 15-S		PG 15-L**		PG 25/-CF	
		L [mm]		L [mm]		L [mm]		L [mm]		L [mm]		L [mm]		L [mm]		L [mm]	
		min.	max.	min.	max.	min.	max.	min.	max.	min.	max.	min.	max.	min.	max.	min.	max.
0.2-1.0	-	21.5*	26.5*	-	-	20*	24*	-	-	-	-	-	-	-	-	-	-
1.5	-	23.5*	26.5*	-	-	16*	20*	-	-	-	-	-	-	-	-	-	-
-	1/16"	23.5*	26.5*	-	-	16*	20*	-	-	-	-	-	-	-	-	-	-
2.0	-	24	26.5	-	-	25	30	-	-	-	-	-	-	-	-	-	-
2.5	-	24*	26.5*	-	-	25	30	-	-	-	-	-	-	-	-	-	-
3.0	-	24	26.5	17	20	25	30	20.5	26	25	30	-	-	-	-	25	32.5
-	1/8"	24*	26.5*	17	20	25	30	20.5	26	25	30	18	25	-	-	25	35.2
3.5	-	-	-	-	-	25	30	-	-	25*	30*	-	-	-	-	25*	35.2*
4.0	-	-	-	-	-	25	30	20.5	26	25	30	18	25	25	53	25	35.2
4.5	-	-	-	-	-	25	30	-	-	25*	30*	-	-	-	-	25*	35.2*
-	3/16"	-	-	-	-	25	30	20.5	26	25	30	18	25	-	-	25	35.2
5.0	-	-	-	-	-	25	30	-	-	25	30	18	25	25	53	25	35.2
5.5	-	-	-	-	-	25	30	-	-	25*	30*	-	-	-	-	25*	35.2*
6.0	-	-	-	-	-	30	35	-	-	33	38	26	33	33	53	33	40.5
-	1/4"	-	-	-	-	30	35	23.5	29	33	38	26	33	33	53	33	40.5
7.0	-	-	-	-	-	-	-	-	-	33	38	-	-	-	-	33	40.5
-	5/16"	-	-	-	-	-	-	-	-	33	38	26	33	33	53	33	40.5
8.0	-	-	-	-	-	-	-	-	-	33	38	26	33	33	53	33	40.5
9.0	-	-	-	-	-	-	-	-	-	33	38	-	-	-	-	33	40.5
-	3/8"	-	-	-	-	-	-	-	-	37	40.5	31	38	37	53	37	44.5
10.0	-	-	-	-	-	-	-	-	-	37	40.5	31	38	37	53	37	44.5
11.0	-	-	-	-	-	-	-	-	-	-	-	-	-	-	-	37	44.5
-	7/16"	-	-	-	-	-	-	-	-	-	-	-	-	-	-	37	44.5
12.0	-	-	-	-	-	-	-	-	-	-	-	-	-	-	-	42	49.5
-	1/2"	-	-	-	-	-	-	-	-	-	-	-	-	-	-	42	49.5
13.0	-	-	-	-	-	-	-	-	-	-	-	-	-	-	-	42	49.5
14.0	-	-	-	-	-	-	-	-	-	-	-	-	-	-	-	42	49.5
-	9/16"	-	-	-	-	-	-	-	-	-	-	-	-	-	-	42	49.5
15.0	-	-	-	-	-	-	-	-	-	-	-	-	-	-	-	42	49.5
-	5/8"	-	-	-	-	-	-	-	-	-	-	-	-	-	-	45.5	50
16.0	-	-	-	-	-	-	-	-	-	-	-	-	-	-	-	45.5	50
18.0	-	-	-	-	-	-	-	-	-	-	-	-	-	-	-	45.5	50
-	3/4"	-	-	-	-	-	-	-	-	-	-	-	-	-	-	47.5	50
20.0	-	-	-	-	-	-	-	-	-	-	-	-	-	-	-	47.5	50
22.0	-	-	-	-	-	-	-	-	-	-	-	-	-	-	-	-	-
-	7/8"	-	-	-	-	-	-	-	-	-	-	-	-	-	-	-	-
25.0	-	-	-	-	-	-	-	-	-	-	-	-	-	-	-	-	-
-	1"	-	-	-	-	-	-	-	-	-	-	-	-	-	-	-	-

\* CF not available. \*\* PG-L without stop screw.

# Presetting range of powRgrip® collets

D	D	PG 25-S		PG 25-L**		PG 32/-CF		PG 32-S		PG 32-L**	
		L [mm]		L [mm]		L [mm]		L [mm]		L [mm]	
		min.	max.	min.	max.	min.	max.	min.	max.	min.	max.
0.2-1.0	-	-	-	-	-	-	-	-	-	-	-
1.5	-	-	-	-	-	-	-	-	-	-	-
-	1/16"	-	-	-	-	-	-	-	-	-	-
2.0	-	-	-	-	-	-	-	-	-	-	-
2.5	-	-	-	-	-	-	-	-	-	-	-
3.0	-	-	-	-	-	-	-	-	-	-	-
-	1/8"	-	-	-	-	-	-	-	-	-	-
3.5	-	-	-	-	-	-	-	-	-	-	-
4.0	-	18	25	-	-	-	-	-	-	-	-
4.5	-	-	-	-	-	-	-	-	-	-	-
-	3/16"	-	-	-	-	-	-	-	-	-	-
5.0	-	-	-	-	-	-	-	-	-	-	-
5.5	-	-	-	-	-	-	-	-	-	-	-
6.0	-	26	33	33	65	33.5	40.9	-	-	-	-
-	1/4"	26	33	33	65	33.5	40.9	-	-	-	-
7.0	-	-	-	-	-	33.5	40.9	-	-	-	-
-	5/16"	26	33	33	65	33.5	40.9	-	-	-	-
8.0	-	26	33	33	65	33.5	40.9	-	-	-	-
9.0	-	-	-	-	-	33.5	40.9	-	-	-	-
-	3/8"	30	38	37	65	35.5	44.9	-	-	-	-
10.0	-	30	38	37	65	35.5	44.9	-	-	-	-
11.0	-	-	-	-	-	35.5	44.9	-	-	-	-
-	7/16"	-	-	-	-	35.5	44.9	-	-	-	-
12.0	-	35	43	42	65	40.5	49.9	32	40.5	40.5	69
-	1/2"	35	43	42	65	40.5	49.9	32	40.5	40.5	69
13.0	-	-	-	-	-	-	-	-	-	-	-
14.0	-	35	43	42	65	40.5	49.9	35	43	40.5	69
-	9/16"	-	-	-	-	40.5	49.9	-	-	-	-
15.0	-	-	-	-	-	-	-	-	-	-	-
-	5/8"	38	46	45.5	65	43.5	52.9	38	46	-	-
16.0	-	38	46	45.5	65	43.5	52.9	35	43.5	43.5	69
18.0	-	-	-	-	-	43.5	52.9	-	-	-	-
-	3/4"	40	47.5	47.5	65	45.5	54.9	37	45.5	45.5	69
20.0	-	40	47.5	47.5	65	45.5	54.9	37	45.5	45.5	69
22.0	-	-	-	-	-	45.5	54.9	-	-	-	-
-	7/8"	-	-	-	-	45.5	54.9	-	-	-	-
25.0	-	-	-	-	-	49.5	58	41	49.5	49.5	69
-	1"	-	-	-	-	49.5	58	41	49.5	49.5	69

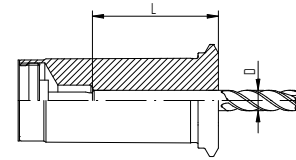

PG / PG-CF / PG-S / PG-L

\* CF not available. \*\* PG-L without stop screw.

# Spindle interface norms

SK	BT	CAPTO	HSK
DIN 69871	MAS 403	ISO 26623	DIN 69893

Type	Measurements [mm]					G
	D1	D2	L1	L2	L3	
<b>SK DIN 69871</b>						
SK 30	31.75	50	3.2	47.8	15.85	M 12
SK 40	44.45	63.55	3.2	68.4	15.85	M 16
SK 50	69.85	97.5	3.2	101.75	15.85	M 24
<b>BT MAS 403</b>						
BT 30	31.75	46	2	48.4	20	M 12
BT 40	44.45	63	2	65.4	25	M 16
BT 50	69.85	100	3	101.8	35	M 24
<b>Polygon shank CAPTO ISO 26623</b>						
Polygon shank C3	32	-	15	19	-	M 12 x 1.5
Polygon shank C4	40	-	20	24	-	M 14 x 1.5
Polygon shank C5	50	-	20	30	-	M 16 x 1.5
Polygon shank C6	63	-	22	38	-	M 20 x 2
Polygon shank C8	80	-	30	48	-	M 20 x 2
<b>HSK DIN 69893</b>						
HSK-A 25	25	19	10	13	2.5	-
HSK-C 25	25	19	8	13	2.5	-
HSK-E 25	25	19	10	13	2.5	-
HSK-A 32	32	24	20	16	3.2	-
HSK-C 32	32	24	10	16	3.2	-
HSK-E 32	32	24	20	16	3.2	-
HSK-A 40	40	30	20	20	4	-
HSK-C 40	40	30	10	20	4	-
HSK-E 40	40	30	20	20	4	-
HSK-A 50	50	38	26	25	5	-
HSK-C 50	50	38	12.5	25	5	-
HSK-E 50	50	38	26	25	5	-
HSK-F 50	50	30	26	20	4	-
HSK-A 63	63	48	26	32	6.3	-
HSK-C 63	63	48	12.5	32	6.3	-
HSK-E 63	63	48	26	32	6.3	-
HSK-F 63	63	38	26	25	5	-
HSK-A 80	80	60	26	40	8	-
HSK-C 80	80	60	16	40	8	-
HSK-F 80	80	48	26	32	6.3	-
HSK-A 100	100	75	29	50	10	-
HSK-C 100	100	75	16	50	10	-
HSK-E 100	100	70	29	50	10	-

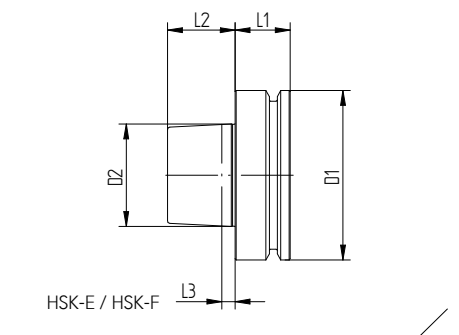
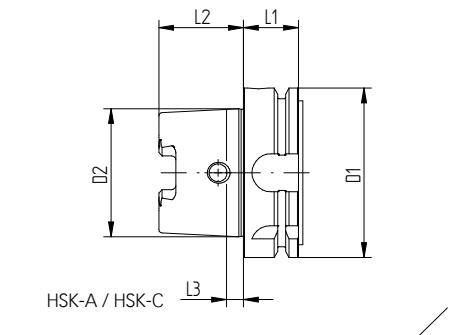
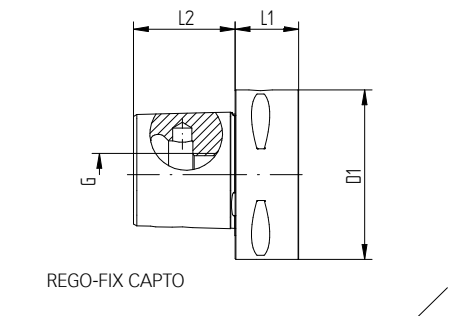
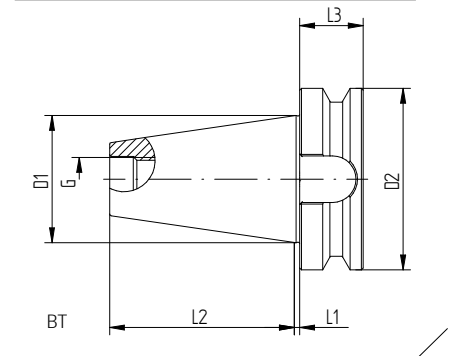
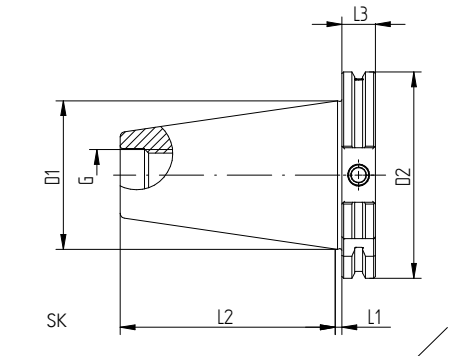

Thread		DIN 371		DIN 357/376	
[mm]	[inch]	Ø	□	Ø	□
M 1	–	2.5	2.1	–	–
M 1.1	–	2.5	2.1	–	–
M 1.2	–	2.5	2.1	–	–
M 1.4	–	2.5	2.1	–	–
M 1.6	1/16	2.5	2.1	–	–
M 1.7	–	2.5	2.1	–	–
M 1.8	–	2.5	2.1	–	–
M 2	–	2.8	2.1	–	–
M 2.2	–	2.8	2.1	–	–
M 2.3	–	2.8	2.1	–	–
M 2.5	3/32	2.8	2.1	–	–
M 2.6	–	2.8	2.1	–	–
M 3	1/8	3.5	2.7	2.2	–
M 3.5	–	4	3	2.5	2.1
M 4	5/32	4.5	3.4	2.8	2.1
M 4.5	3/16	6	4.9	3.5	2.7
M 5	–	6	4.9	3.5	2.7
M 6	1/4	6	4.9	4.5	3.4
M 7	5/16	7	5.5	5.5	4.3
M 8	–	8	6.2	6	4.9
M 9	–	9	7	7	5.5
M 10	3/8	10	8	7	5.5
M 11	–	–	–	8	6.2
M 12	1/2	–	–	9	7
M 14	9/16	–	–	11	9
M 16	5/8	–	–	12	9
M 18	11/16	–	–	14	11
M 20	13/16	–	–	16	12
M 22	7/8	–	–	18	14.5
M 24	15/16	–	–	18	14.5
M 27	1/16	–	–	20	16
M 30	3/16	–	–	22	18

All dimensions in mm (except US Standard ASME B 94.9 in inch).

\*M 3–M 10 with reinforced shank.

# Additional information

Maximum presetting range for PG standard collets and PG-CF collets

Sizes	PG 6	PG 10	PG 15	PG 25	PG 32
L2 max.	26.5	35	40.5	50	58

L2 = maximum depth (without stop screw)

Presetting range of PG-TAP collets with internal square

Dimensions [mm]		PG 15-TAP [mm]		PG 25-TAP [mm]	
D	SW	L min.	L max.	L min.	L max.
3.5	2.7	27	29	–	–
4.5	3.4	27	29	–	–
6.0	4.9	29	31	–	–
7.0	5.5	29	31	–	–
8.0	6.2	33.5	36	33.5	36
9.0	7	34.5	37	34.5	37
10.0	8	35.5	38	38.5	41
11.0	9	–	–	39.5	42
12.0	9	–	–	39.5	42
14.0	11	–	–	41.5	44
16.0	12	–	–	42.5	45

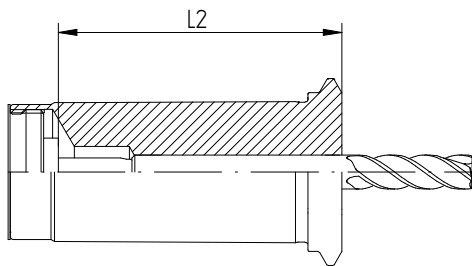

PG / PG-CF

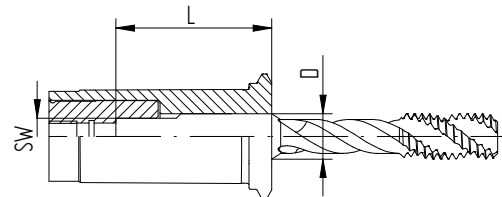

PG-TAP

Recommended tightening torque for secuRgrip® safety nuts

Safety nut type	Nut Ø [mm]	Recommended torque	Freewheel wrench head	TORCO-FIX
PG 15	28.00	50 Nm	A-FLS Ø 28.0 / MR 16 / SG 15	II
PG 25	46.00	70 Nm	A-FLS Ø 46.0 / SG 25	II
PG 32	55.00	80 Nm	A-FLS Ø 55.0 / SG 32	II



## h6 shank tolerances

<b>Metric</b>	<b>Tolerance</b>	<b>Minimum Size</b>	<b>Inch conversion</b>
2.00	0.0060	1.9940	0.07850
3.00	0.0060	2.9940	0.11787
4.00	0.0080	3.9920	0.15717
5.00	0.0080	4.9920	0.19654
6.00	0.0080	5.9920	0.23591
7.00	0.0090	6.9910	0.27524
8.00	0.0090	7.9910	0.31461
9.00	0.0090	8.9910	0.35398
10.00	0.0090	9.9910	0.39335
11.00	0.0110	10.9890	0.43264
12.00	0.0110	11.9890	0.47201
13.00	0.0110	12.9890	0.51138
14.00	0.0110	13.9890	0.55075
15.00	0.0110	14.9890	0.59012
16.00	0.0110	15.9890	0.62949
17.00	0.0110	16.9890	0.66886
18.00	0.0110	17.9890	0.70823
19.00	0.0130	18.9870	0.74752
20.00	0.0130	19.9870	0.78689
22.00	0.0130	21.9870	0.86563
25.00	0.0130	21.9870	0.98374

<b>Fractional</b>	<b>Decimal</b>	<b>Tolerance</b>	<b>Minimum Size</b>
1/8	0.125	0.00024	0.12476
3/16	0.1875	0.00031	0.18719
1/4	0.250	0.00035	0.24965
5/16	0.3125	0.00035	0.31215
3/8	0.375	0.00035	0.37465
7/16	0.4375	0.00043	0.43707
1/2	0.500	0.00043	0.49957
9/16	0.5625	0.00043	0.56207
5/8	0.625	0.00043	0.62457
3/4	0.750	0.00051	0.74949
7/8	0.875	0.00051	0.87449
1	1.000	0.00051	.099949

# Get in touch

We love to talk to you and share our toolholding expertise to maximize your productivity.

## **REGO-FIX Tool Corp.**

4420 Anson Blvd / Whitestown / IN 46075 / USA  
Toll Free 800-999-7346 / Phone 317-870-5959 / Fax 317-870-5955  
info@rego-fix.com / www.rego-fix.com

---

REGO-FIX AG is ISO certified:  
ISO 9001 for quality management / since 1996  
ISO 14001 for environmental management / since 2007

---

This document should not be used or relied on for any purpose other than that intended by REGO-FIX.

---

The data given in this catalog are dependent on the conditions under which they are measured and are derived from tests carried out under defined lab conditions at REGO-FIX AG. The performance of these tools depends on the conditions under which they are used and may vary from case to case. The information given in this catalog is believed to be correct. REGO-FIX however assumes no responsibility or liability for any errors, inaccuracies or omissions that may appear in this catalog. Information in this catalog is subject to change without notice and should not be construed a commitment by REGO-FIX or its subsidiaries. This is especially valid for adaptations to new or changed international standards or improvements to the products performance or production processes.

---

Softsynchro® is a registered trademark of EMUGE-Werk Richard Glimpel GmbH & Co. KG. Viton® is a brand of synthetic rubber and fluoropolymer elastomer of DuPont Performance Elastomers. Capto® is a registered trademark of AB Sandvik Coromant.

© Copyright 2016 REGO-FIX Tool Corp.





**Swiss quality standard**

Our products marked Swiss made are manufactured at our headquarters in Tenniken, Switzerland.

